

LB10391

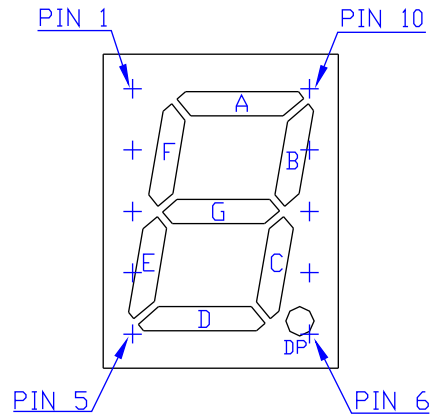

CODE E

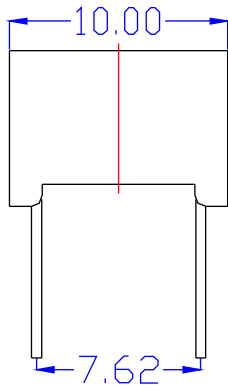
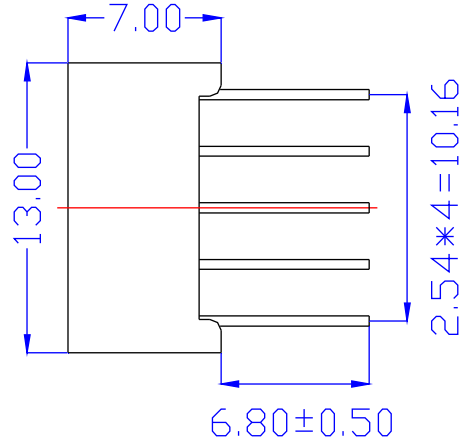
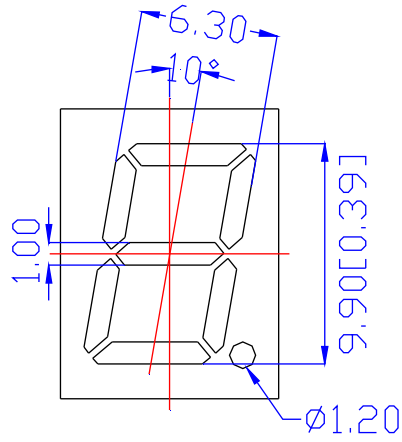
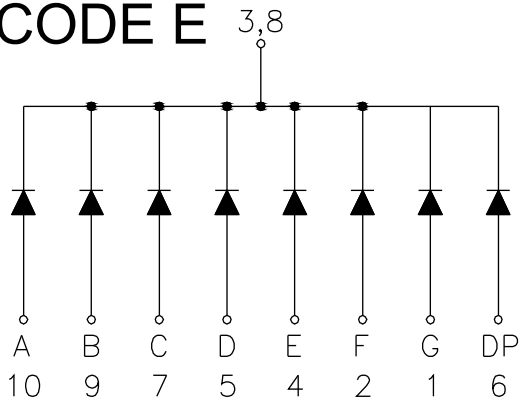

Common Cathode

CODE B

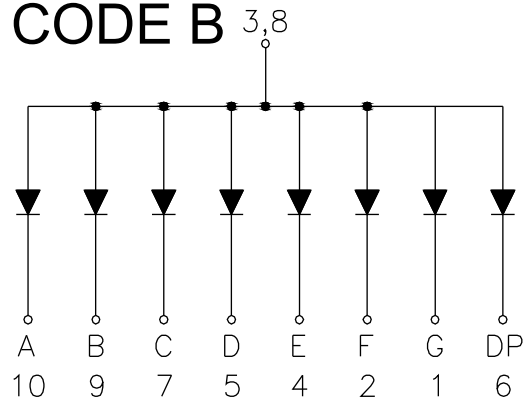

Common Anode