

LB10521

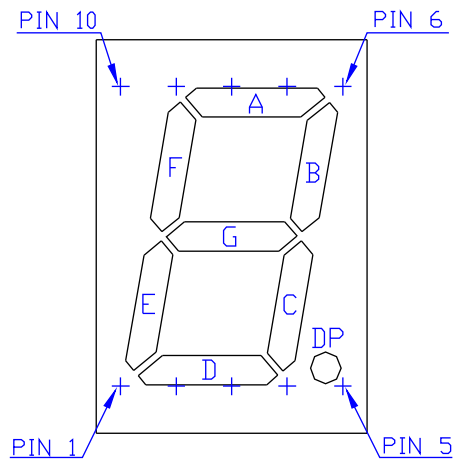

CODE E

3,8

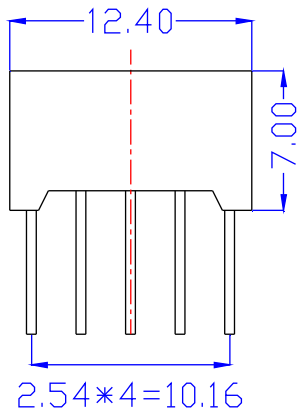
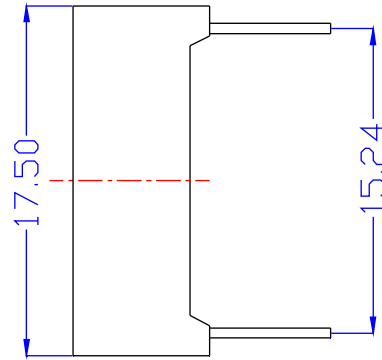
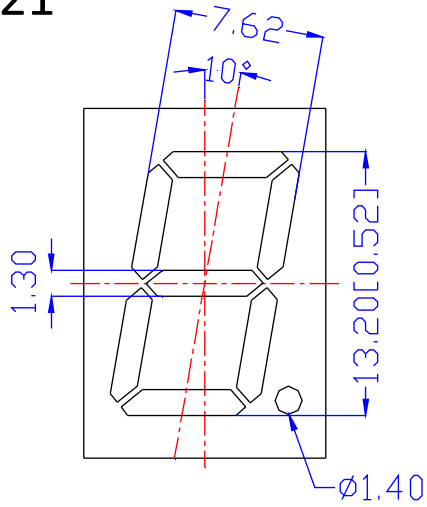
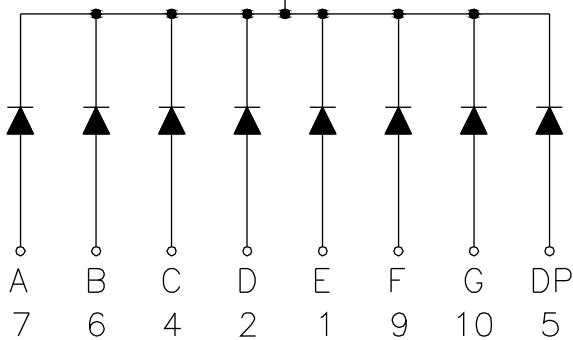

Common Cathode

CODE B

3,8

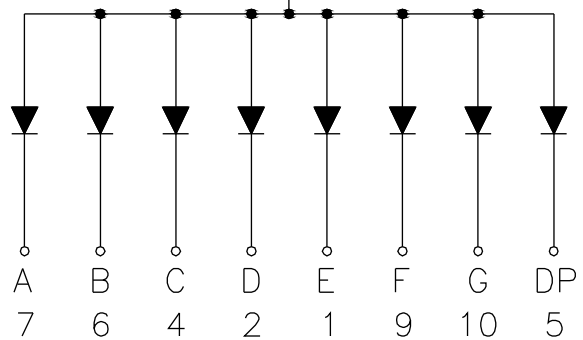

Common Anode