

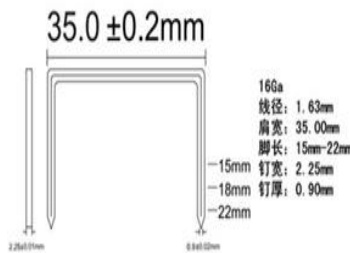

FEDELOR FASTENERS INDUSTRIAL LTD
 FEDELOR(HONGKONG) FASTENERS LIMITED
 TEL/FAX:+86-22-68685906
 PH/WHATSAPP:+8618512209537
 www.fedelor.com jameszhang@fedelor.com

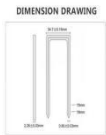

CARTON CLOSING STAPLES 1/2

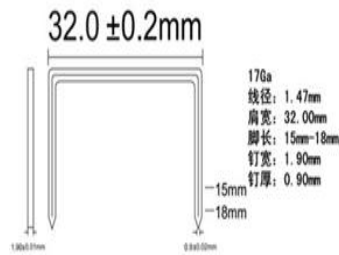
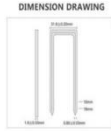

PRODUCTS	32 Series
MATERIAL	Q195
SURFACE	Galv, Cooper
COLOR	Natural, Cooper
TENSILE	45-55kg/mm ²
SHEAR FORCE	8-10kg
FEET LENGTH	15mm, 18mm
DELIVERY TIME	25-35 days after order confirmed

PRODUCTS	35 Series
MATERIAL	Q195
SURFACE	Galv, Cooper
COLOR	Natural, Cooper
TENSILE	45-55kg/mm ²
SHEAR FORCE	8-10kg
FEET LENGTH	15mm, 18mm
DELIVERY TIME	25-35 days after order confirmed

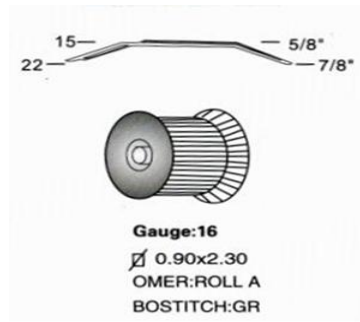
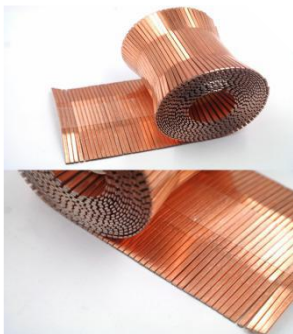

PRODUCTS	GR Series
MATERIAL	Q195
SURFACE	Galv, Cooper
COLOR	Natural, Cooper
TENSILE	45-55kg/mm ²
SHEAR FORCE	8-10kg
DIAMETER	2.3mm*0.9mm
SHOULDER BREADTH	35mm
FEET LENGTH	15mm, 18mm, 22mm
DELIVERY TIME	25-35 days after order confirmed

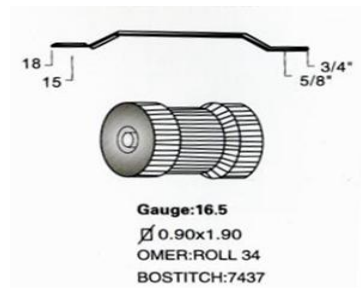
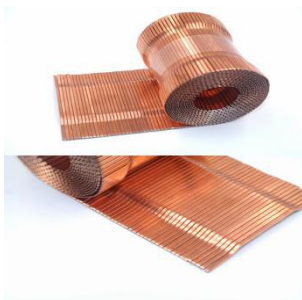

PRODUCTS	SWC7437 Series
MATERIAL	Q195
SURFACE	Galv, Cooper
COLOR	Natural, Cooper
TENSILE	45-55kg/mm ²
SHEAR FORCE	8-10kg
DIAMETER	1.9mm*0.9mm
SHOULDER BREADTH	35mm
FEET LENGTH	15mm, 18mm
DELIVERY TIME	25-35 days after order confirmed

CARTON CLOSING STAPLES 2/2

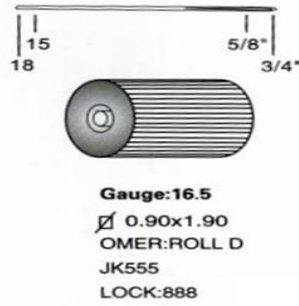
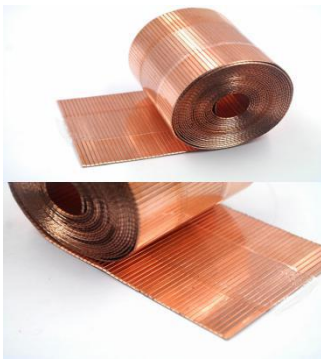

PRODUCTS	JK555 Series
MATERIAL	Q195
SURFACE	Galv, Cooper
COLOR	Natural, Cooper
TENSILE	45-55kg/mm ²
SHEAR FORCE	8-10kg
DIAMETER	1.9mm*0.9mm
FEET LENGTH	15mm, 18mm
DELIVERY TIME	25-35 days after order confirmed

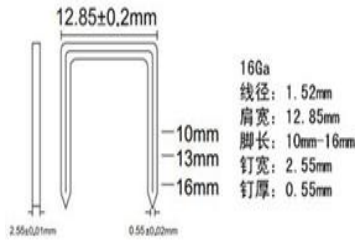
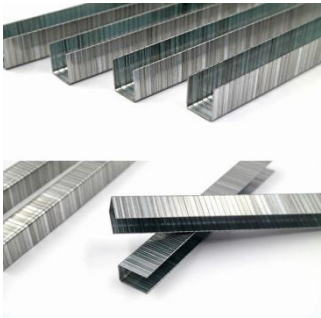

PRODUCTS	SB10 30 20 Series
MATERIAL	Q195
SURFACE	Galv
COLOR	Natural
TENSILE	45-55kg/mm ²
SHEAR FORCE	8-10kg
FEET LENGTH	10mm, 13mm, 16mm
DELIVERY TIME	25-35 days after order confirmed

COIL NAILS 1/2

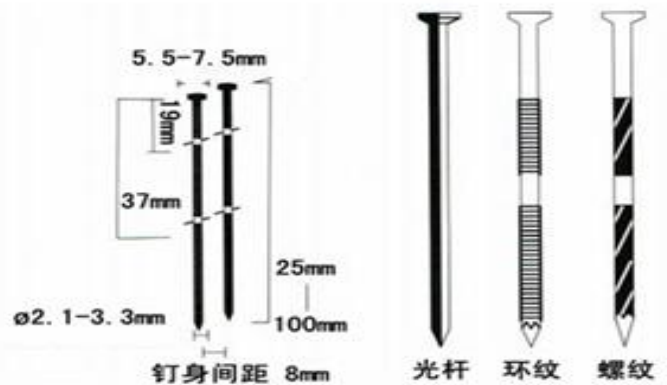

DIA/INCH	LEGTH/INCH	PCS/COIL	SHANK	SURFACE TREATMENT
0.083"	1-1/4"—2"	400-350	SMOOTH SCREW RING	BRIGT, GALV, VINLY
0.90"	1-1/4"—2-1/2"	400-300		
0.92"	1-1/4"—2-1/2"	400-300		
0.99"	1-1/2"—2-1/2"	300		
0.105"	1-1/2"—2-3/4"	250--225		
0.113"	1-3/4"—3"	250--225		
0.120"	2"—3-1/2"	250--200		
0.131"	2-3/8"—3-1/2"	200		
0.148"	2-3/8"—3-1/2"	150		
0.162"	2-3/8"—3-1/2"	150		

COIL NAILS 2/2



DIA/INCH	LEGTH/INCH	PCS/COIL	SHANK	SURFACE TREATMENT
0.083"	1-1/2"—2"	3000	SMOOTH SCREW RING	BRIGT, VINLY
0.090"	1-1/2"—2-1/2"	3000		
0.092"	1-1/2"—2-1/2"	3000		
0.099"	1-1/2"—2-1/2"	2000		
0.105"	1-1/2"—2-3/4"	2000		
0.113"	1-3/4"—3"	1500		

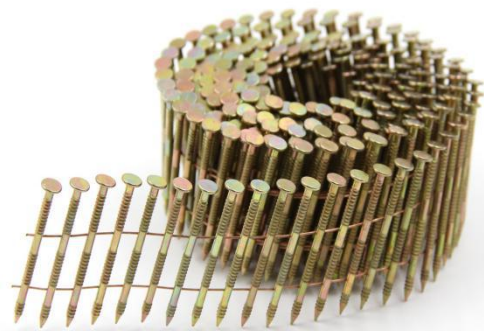

BRAD

T NAIL (18 Gauge)

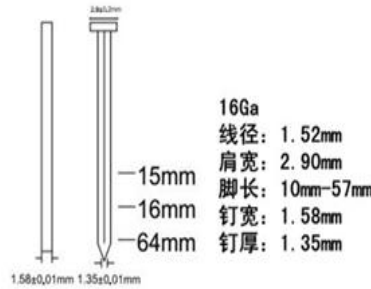

PRODUCTS	T Series(16 GA)
MATERIAL	Q235
SURFACE	Galv
COLOR	Natural
TENSILE	45-55kg/mm ²
SHEAR FORCE	95-105kg
DIAMETER	1.58mm*1.35mm
FEET LENGTH	15mm、16mm、64mm
DELIVERY TIME	25-35 days after order confirmed

F NAIL (18 Gauge)

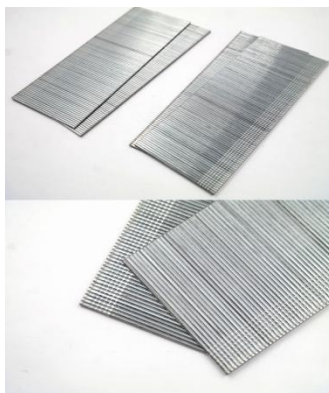

PRODUCTS	F Series(18 GA)
MATERIAL	Q235
SURFACE	Galv
COLOR	Natural
TENSILE	45-55kg/mm ²
SHEAR FORCE	95-105kg
DIAMETER	1.25mm*1.0mm
FEET LENGTH	10mm、12mm、57mm
DELIVERY TIME	25-35 days after order confirmed

DA NAIL(15 Gauge)

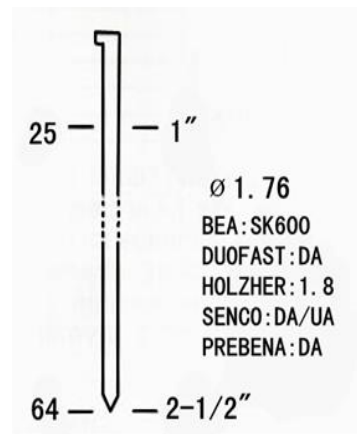
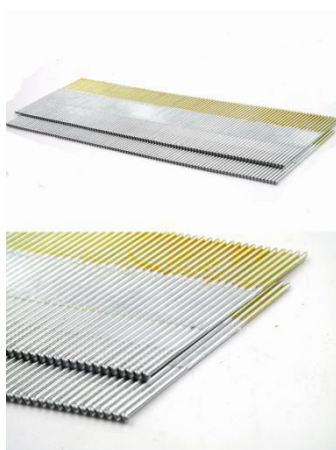

PRODUCTS	DA Series
SIZE	15 GA
DIAMETER	1.76mm-1.78mm
MATERIAL	Q235
SURFACE	Galv、Bright、304Stainless Steel
TENSILE	1000-1100N/mm ²
HEAD	D
POINT	Diamond tip/Blunt tip
HEAD LENGTH	3.10mm*2.45mm
SHOULDER BREADTH	35±1°
PCS/ROW	50Pcs/100Pcs
DELIVERY TIME	25-35 days after order confirmed

PIN NAIL 1/2

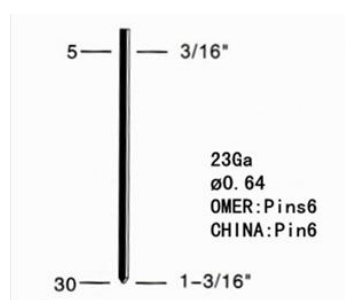

PRODUCTS	Pins6 Series
MATERIAL	Q235
SURFACE	Galv、Cooper
COLOR	Natural、Cooper
WIDTH	0.64mm
THICK	0.64mm
FEET LENGTH	15mm-30mm
DELIVERY TIME	25-35 days after order confirmed

PIN NAIL 1/2

PINS8



PINSAP

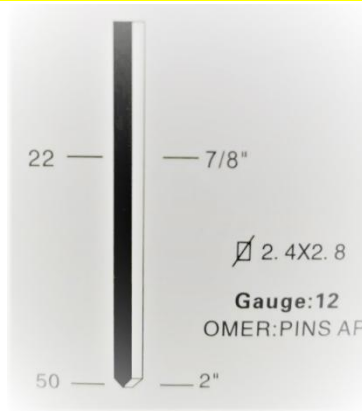

PINSL



FINISH NAIL ST/FST CONCRETE NAIL

ST

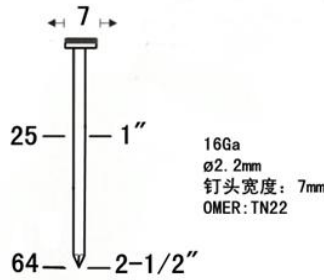
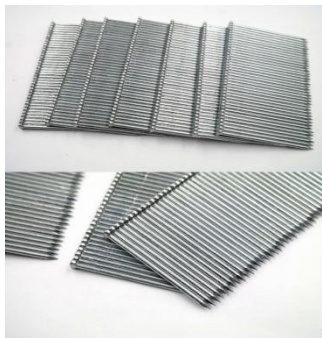

PRODUCTS	ST Concrete Series
MATERIAL	Medium Carbon steel
SURFACE	Galv
SHEAR FORCE	130-160kg/mm ²
DIAMETER	2.18-2.2mm
HEAD	6.0mm
POINT	Diamond tip
DELIVERY TIME	25-35 days after order confirmed

FST

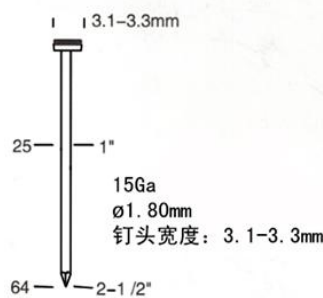
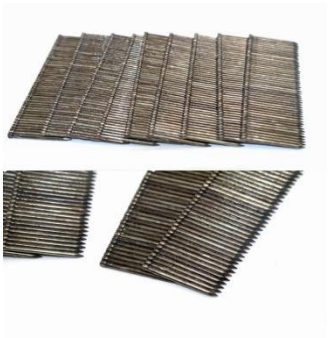

PRODUCTS	FST Concrete Series
MATERIAL	Medium Carbon steel
SURFACE	Galv
SHEAR FORCE	130-160kg/mm ²
DIAMETER	1.8mm
HEAD	3.1-3.3mm
POINT	Diamond tip
DELIVERY TIME	25-35 days after order confirmed

WTHT



PRODUCTS	WTHT Concrete Series
MATERIAL	Low Carbon steel
SURFACE	Galv
SHEAR FORCE	90-125kg/mm ²
DIAMETER	2.18-2.2mm
HEAD	6.0mm
POINT	Diamond tip
DELIVERY TIME	25-35 days after order confirmed

PAPER STRIP NAIL

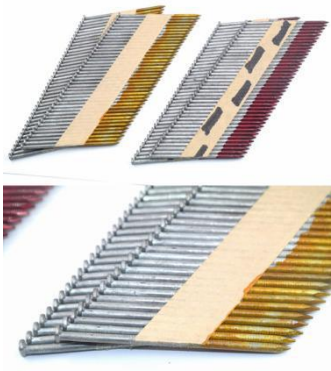

PRODUCTS	Paper Strip Series
MATERIAL	Q235
SURFACE	Galv, Bright, Stainless Steel
SLOPE	28-34°
HEAD	D/C
SHANK	Smooth Screw Ring
DIAMETER	2.9-3.3mm
FEET LENGTH	50mm--100mm
DELIVERY TIME	25-35 days after order confirmed

PLASTIC STRIP NAIL

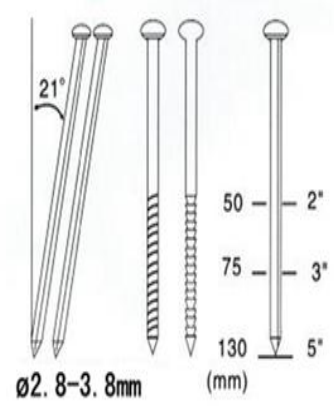
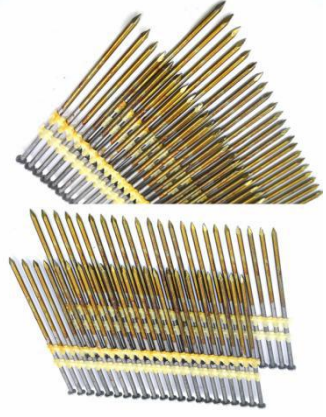

PRODUCTS	Paper Strip Series
MATERIAL	Q235
SURFACE	Galv, Bright, Stainless Steel
SLOPE	28-34°
HEAD	D/C
SHANK	Smooth Screw Ring
DIAMETER	2.9-3.3mm
FEET LENGTH	50mm--100mm
DELIVERY TIME	25-35 days after order confirmed

FLOORING FASTENERS

T-HEAD CLEATS NAIL

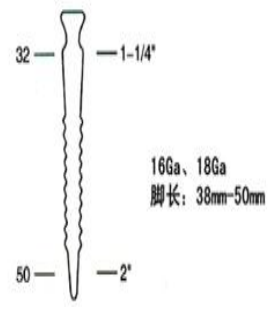
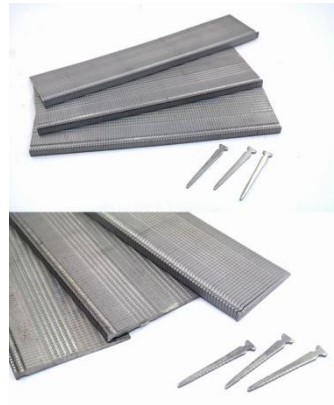

PRODUCTS	T-Head Cleats Series
MATERIAL	Q195
SPECIFICATION	16Ga, 18Ga, 20Ga
FEET LENGTH	38mm, 45mm, 50mm
WIDTH	4.7mm
THICK	1.50mm
DELIVERY TIME	25-35 days after order confirmed

L-HEAD CLEATS NAIL

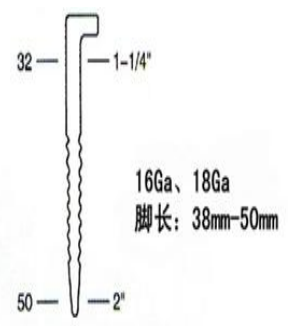
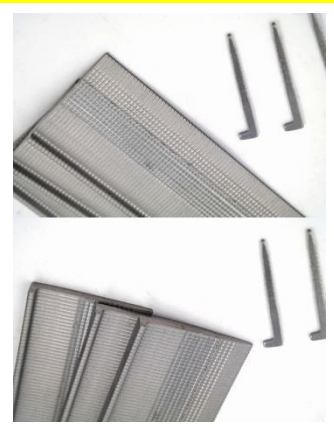

PRODUCTS	L-Head Cleats Series
MATERIAL	Q195
SPECIFICATION	16Ga, 18Ga, 20Ga
FEET LENGTH	38mm, 45mm, 50mm
WIDTH	4.7mm
THICK	1.50mm
DELIVERY TIME	25-35 days after order confirmed

WOOD CONSTRUCTION SCREW (WAFER HEAD AND FLAT HEAD)

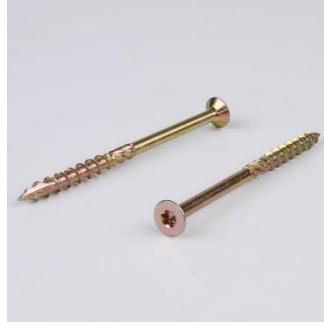

HEX HEAD SELF DRILLING SCREWS



LONG SCREWS FROM 80MM TO 400MM



OEM SHOW 1/2



OEM SHOW 2/2



WORK SHOP STAMPLS, BRADS 1/3



WORK SHOP SCREWS 2/3



WORK SHOP COIL NAILS 3/3



FEDELOR FASTENERS INDUSTRIAL Ltd. is a wholly-owned import and export trading company of FEDELOR fasteners factory. The company uses Ameba management principle, originates from industry and trade, and operates independently at the same time. It guarantees the independent accounting of production department, pays attention to production capacity, quality and delivery time, and takes the idea of customer first and takes market as guidance. To ensure that the factory is in full service to customers. Our factory was established in 2010, specializes in the production and processing of "FEDELOR" series of brand sealed box packing nails, furniture nails, all kinds of straight nails, rattan craft nails, coil nails, screws, wire board, galvanized copper-plated wire and other products, mainly used in engineering, home decoration, furniture manufacturing, packaging, leather, shoe-making handicrafts and other industries, the products are welcomed by domestic manufacturers and Exports to Europe, the United States, Southeast Asia and so on nearly more than 20 countries and regions. All the products are made of high-quality wire rods, strictly in accordance with ISO 9001 international standards and GBQILXD01-2002 national standards for production. The company's headquarters is located in the national production and processing center of high-quality galvanized wire - Jinghai District, Tianjin, near Tianjin Xingang, from the Beijing-Shanghai high-speed entrance 4 km, convenient transportation. After years of development, our company's integrity, strength and product quality have been recognized by the industry. Honesty and integrity make our team and customers + Partners closely together, professional so that we always maintain a leading position in the domestic industry, we will always be customer-centric, think what you want to think.

GOAL:

Best quality+Competive price+Punctual delivery+ Good service=Long-term cooperation!

FEDELOR FASTENERS INDUSTRIAL LTD.

FEDELOR(HONGKONG) FASTENERS LIMITED

WWW.FEDELOR.COM

Add:Yangjiayuan Industry Zone, Jinghai District,Tianjin City,China.301600.

Email: kay@fedelor.com jameszhang@fedelor.com

Ph:008615971541116 008618512209537

Tel: 0086-22-68685906 Fax:0086-68685906