

Product specification

Name : ONN-LED machine work light

Model : ONN-M4S series

Version : A0

Date : 2015-01-28

Products introduce:

1. Delicate structure, simple and beautiful, competitive price;
2. The radiating of light is good, to insure the life spans of products;
3. China famous power.

Products photo, drawing and wiring diagram:

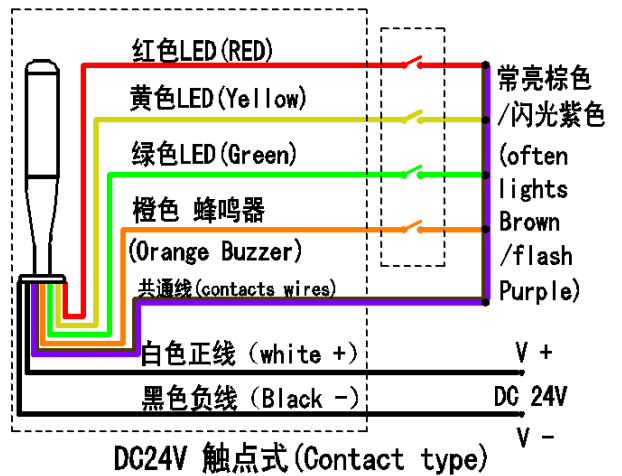
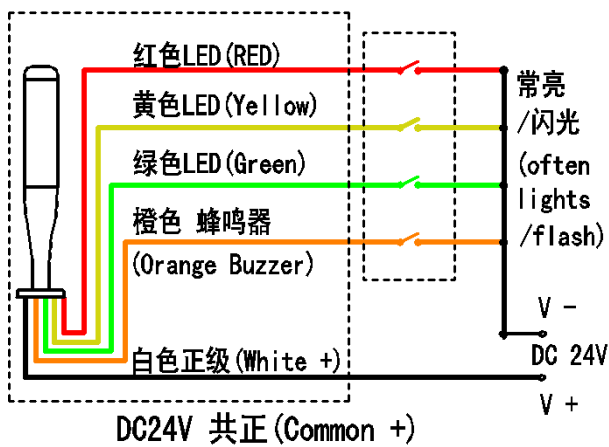
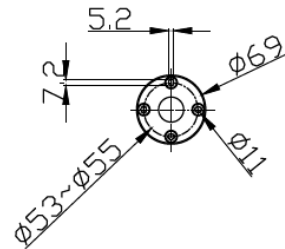
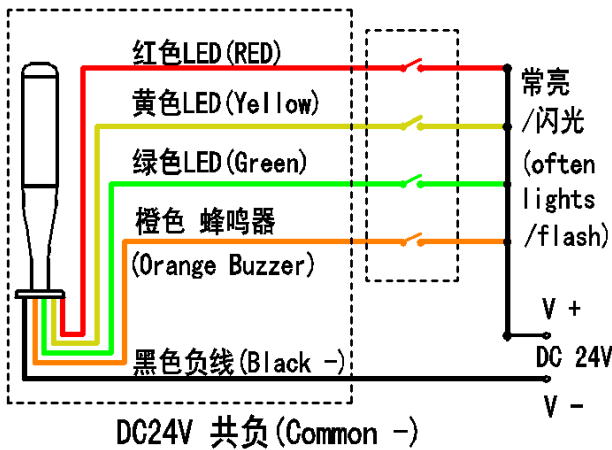
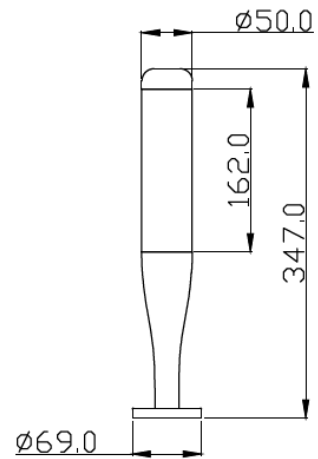
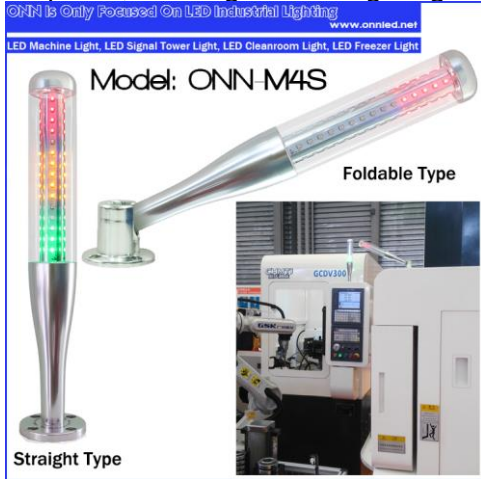

Product Code Principles:

ONN -M4S A - 3 B B B	
① ② ③ ④ ⑤ ⑥ ⑦	
①	Name: ONN
②	Three-color light color stick series: M4S
③	Shape: A straight B, foldable type
④	Color quantity: 3 colors
⑤	Voltage: B, 24V
⑥	Wiring: C: contact type (with a brown color common line) Z:NPN(Common-) B: PNP(Common-)
⑦	B, Steady light F, steady light with buzzer S, Red flashing C, Red flashing with buzzer D, All flashing E, All flashing with buzzer

Parameters					
Model No.:		M4S			
Input voltage	DC24V	Input Current	60~200mA	Power	Single color: 1.2~2.4 W Total power: 5W
IP rating	IP50	Length	□0.5M □		
Special request:					
Brand	ONN, Shenzhen ONN Semi-conductor				
Light	Chips 3528 LED 0.06W/pcs				
Life spans	Life spans of light is 100000 hrs; the whole light life: 50000 hrs				
Beam angle	Single light 120 degree, 360 degree visible for whole tower light				
Original place	Shenzhen China				
Products shape					
Shape design	Baseball bat type, Smooth curve over, Advanced plating.				
Color of light body	silver				
Material	PC (Bulletproof plastic) 、ABS Engineering Plastics				

Shenzhen Onn Semi-conductor lighting Co.,Ltd

Environmental Requirements:

Working temperature:	-20~45℃
Save temperature:	-40~70℃
Working humidity:	10~90%
Save humidity:	10~90%

Packing:

Packing material	cartons
N/W of one light (Kg)	0.5
G/W of total cartons (Kg)	8.2
Qty in carton (PCS)	12
Size of inner box (L*W*H) mm	415*80*80mm
Size of outer carton (L*W*H) mm	440*265*345mm

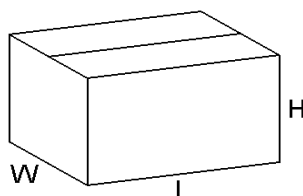
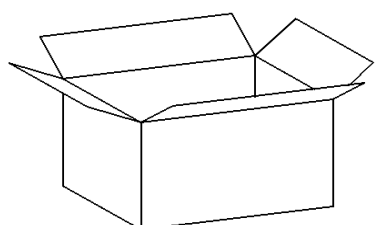

Shenzhen Onn Semi-conductor lighting Co.,Ltd