

1. model no. : SL631, price is \$800/set, FOB Qingdao



pls note the specification as following:

SL631 Automatic Car Tyre Changer

Specifications:

1. External Locking Rim Dimensions: 300mm-510mm (12"- 22")
2. Internal Locking Rim Dimensions: 355mm-585mm (14"- 24")
3. Max Tyre Diameter: 1280mm (50")
4. Max Tyre Width: 460mm (18")
5. Bead Breaker Force (10bar) : 2500Kg
6. Working Pressure: 8-10bar(116-145Psi)
7. Voltage: 110V/220V (1ph), 380V (3ph)
8. Motor Power: 0.75Kw-1.1Kw
9. Noise: <70dB
10. Technical features:
 - Pneumatic Bead Breaker blade
 - Manometer for inflating pressure control equipped with deflating push button
 - Water box in case
11. Net Weight: 256Kg
- Gross Weight: 298Kg

2. model no. is SL780, price is \$990/set, FOB Qingdao



pls note the following specification:

1. External Locking Rim Dimensions: 300mm-510mm (12"- 20")
2. Internal Locking Rim Dimensions: 350mm-609mm (14"- 24")
3. Max Tyre Diameter: 1000 mm (39")
4. Max Tyre Width: 410 mm (16")
5. Bead Breaker Force (10bar) : 2500Kg
6. Working Pressure: 8-10bar(116-145Psi)
7. voltage: 110/220V (1ph) 380V (3ph)
8. Motor Power: 0.75Kw-1.1Kw
9. Technical features:
 - with oil reserve tank
 - rapid air inflation
 - Pneumatic Bead Breaker blade
 - controlled pressure gage
 - large tank to invoid rocking bar inclining
10. net weight: 336kgs
 - gross weight: 397kgs

3. model no. is SL620(F), the price is \$650/set, FOB Qingdao

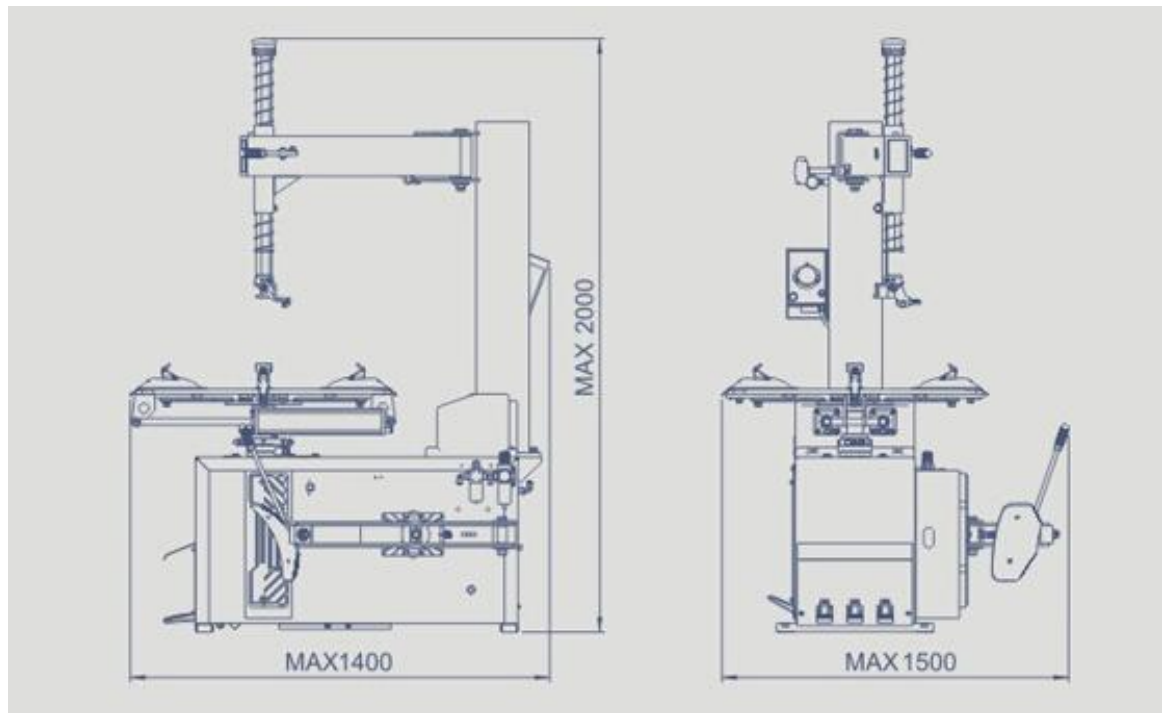

pls note the following specification:

■ 技术参数 TECHNICAL SPECIFICATION		»
	外夹轮辋 Outside Clamp	11-24°
	内撑轮辋 Inside Clamp	13-26°
	轮胎宽度 Tire Width	3-15°
	最大车轮直径 Max Wheel Diameter	1250MM
	工作气压 Working air pressure	8-10bar
	转盘转速 Turntable Rotation Speed	6.5rpm
	电源电压 Power Supply Voltage	110V/220V/380V
	功率 Power	0.75/1.1kW
	噪音 Noise	<70dB

■ FEATURES >











- * The mounting head is made of special steel and lifetime warranty.
- * The hexangular shaft with 41mm diameter is suitable for operation the flat and hard tire.
- * Bead breaker arm structure optimization increases the bead break power by 1.5 times.
- * The machine adopts the parkerising bead breaker cylinder having bead break power 2500KG to bead break the tire from rim easily.
- * The machine equips the protective cover for clamps and mounting head as standard configuration to avoid damage the rim.
- * The wearable washers as standard correspond to Europ standard to protect the personal safety when mounting the tire.
- * There're obligate holes on the machine body which can be optional to install the PI330 A or PL240 helper.
- * The universal switch is 40A with a pure silver touching point, it can bear great load with a long using life.

4 model no.: SL04, price is \$1200/set, FOB Qingdao



Pls note the following specification

■ 技术参数 TECHNICAL SPECIFICATION »

	外夹轮辋 Outside Clamp	10-20"
	内撑轮辋 Inside Clamp	12-23"
	轮胎宽度 Tire Width	3-12"
	最大车轮直径 Max Wheel Diameter	1120MM
	工作气压 Working air pressure	8-10bar
	转盘转速 Turntable Rotation Speed	6.5rpm
	电源电压 Power Supply Voltage	110V/220V/380V
	功率 Power	0.75/1.1kW
	噪音 Noise	<70dB
	包装尺寸 CTN.size	1100×910×1010 1280×550×450
	净重/毛重 Net weight/Gross Weight	246/285 72/95

■ FEATURES »

- * The mounting head is made of special steel and lifetime warranty.
- * The wearable washers as standard correspond to Europ standard to protect the personal safety when mounting the tire.
- * The control pedal assembly has the step-move function which can stop the clamp at any position to clamp the rim conveniently.
- * The machine adopts the parkerising bead breaker cylinder having bead break power 2500KG to bead break the tire from rim easily.
- * The machine equips the protective cover for clamps and mounting head as standard configuration to avoid damaging the rim.
- * There're obligate holes on the machine body which can be optional to install the left helper BT160,BT180.
- * The clamp is made of special material, strong and durable.
- * The universal switch is 40A with a pure silver touching point, it can bear great load with a long using life.

5. Model no.: SL586, price is \$590/set, FOB Qingdao



Pls note the specifications as following:

- 1.External Locking Rim Dimensions: 280mm-510mm (10"- 20")
- 2.Internal Locking Rim Dimensions: 325mm-585mm (12"- 24")
- 3.Max Tyre Diameter: 950mm (37")
- 4.Max Tyre Width: 410 mm (16")
- 5.Bead Breaker Force (10bar) : 2500Kg
- 6.Working Pressure: 8-10bar(116-145Psi)
- 7.voltage: 110/220V (1ph) 380V (3ph)
- 8.Motor Power: 0.75Kw-1.1Kw
- 9.noisy: <70dB
- 10.Technical features:
Pneumatic Bead Breaker blade
controlled pressure gage
Net weight: 207kgs
Gross weight: 245kgs

6. Model no. : F586, price is \$585/set, FOB Qingdao



Pls note the specifications as following:

1. External Locking Rim Dimensions: **300mm-510mm (10"- 20")**
2. Internal Locking Rim Dimensions: **355mm-615mm (12"- 24")**
3. Max Tyre Diameter: **1040mm**
4. Max Tyre Width: **410mm**
5. Bead Breaker Force (10bar) : 2500Kg
6. Working Pressure: 8-10bar(116-145Psi)
7. voltage: 110/220V (1ph) 380V (3ph)
8. Motor Power: 0.75Kw-1.1Kw
9. noisy: <70dB
10. Technical features:
Pneumatic Bead Breaker blade
controlled pressure gage
11. Net weight: 256kgs
Gross weight: 298kgs

7. Model no. : T568, price is \$2350/set, FOB Qingdao
 This one is for truck tyre.



Pls note the specification as following:

TECHNICAL DATA 技术参数	
Rim diameter 轮辋直径	14" -26"
Max.wheel weight 最大车轮重量	500kg
Max.wheel width 最大车轮宽度	780mm
Max.tyre diameter 最大轮胎直径	1600mm
Hydraulic pump motor 液压动力单元	1.5kw 380v-3ph(220V Optional)
Gearbox motor 齿轮箱电机	1.8kw 380v-3ph(220v Optional)
Bead breaker force 胎边压力	2500kg
Operation control voltage 移动控制手柄电压	24V
Machine weight approx 设备净重	570kg
Overall dimensions approx 设备占地面积	2500 × 2000mm
Power 电压	220/400V 50/60Hz1P/3P Optional

WEIGHT&DIMENSIONS 重量&包装尺寸		
Model	Gross Weight (kg)	Outside Dimension L×W×H (mm)
T568	647	2030×1600×1000

8. Model no. is SL694, price is \$4850/set, FOB Qingdao



SL694 automatic truck tyre changer

Double speed bidirectional chuck

specification:

- 1.max tyre diameter:2500mm (100")
- 2.rim diameter: 350mm-1400mm(14"-56")
- 3.max tyre width:1200mm (48")
- 4.max tyre weight:2200Kg
- 5.power:2.4KW/3.0Kw
- 6.main power: 2.4KW/3.0Kw
- 7.voltage: 230V,400V, 1ph/3ph. 50Hz/60Hz
- 8.net weight: 1000Kg gross weight: 1200Kg

9. Model no. Is BT-610, price is \$520/set, FOB Qingdao



■ 技术参数 TECHNICAL SPECIFICATION >>		
	外夹轮辋 Outside Clamp	10-18"
	内撑轮辋 Inside Clamp	12-21"
	轮胎宽度 Tire Width	3-12"
	最大车轮直径 Max Wheel Diameter	960MM
	工作气压 Working air pressure	8-10bar
	转盘转速 Turntable Rotation Speed	6.5rpm
	电源电压 Power Supply Voltage	110V/220V/380V
	功率 Power	0.75/1.1kW
	噪音 Noise	<70dB
	包装尺寸 CTN.size	980×760×950
	净重/毛重 Net weight/Gross Weight	179/207

■ FEATURES >>	
* The mounting head is made of special steel	
* The control pedal assembly has the step-move function which can stop the clamp at any position to clamp the rim conveniently.	
* The machine adopts the parkerising bead breaker cylinder having bead break power 2500KG to bead break the tire from rim easily.	
* The machine equips the protective cover for clamps and mounting head as standard configuration to avoid damaging the rim.	
* The clamp is made of special material, strong and durable.	
* The universal switch is 40A with a pure silver touching point, it can bear great load with a long using life.	

10. Model no. Is SL-505, price is \$500/set, FOB Qingdao

SL-505

轮胎拆装机

 <p>最大轮胎直径 900mm</p>	 <p>最大轮胎宽度 300mm</p>	 <p>电源电压 220V/380V</p>	 <p>电机功率 1.1Kw/0.75Kw</p>
 <p>内撑轮辋 12"-20"</p>	 <p>外夹轮辋 10"-18"</p>	 <p>靠胎压力 2500kg</p>	 <p>操作气压 8-10bar</p>

11. Model no. Is T980, price is \$4900/set, FOB Qingdao

T980 SUPER



56°

- T980 SUPER TRUCK TYRE CHANGER HAS BEEN SPECIFICALLY DESIGNED TO MOUNT AND DEMOUNT TYRES FROM TRUCKS, BUSES,TRACTORS AND EARTHMOVING VEHICLES
- RIM CAPACITY 14" -56"
- BI-DIRECTIONAL CHUCK WITH 2 ROTATIONAL SPEEDS
- ITALIAN PUMP OPTIONAL

- 适用于卡车，客车，拖拉机，工程车等轮胎
- 轮辋直径14" -56"
- 双速
- 意大利泵可选



Wireless Remote Control Unit
OPTIONAL 遥控可选

TECHNICAL DATA 技术参数

Rim diameter 轮辋直径	14" -46"
Rim capacity(with extensions)	14" -56"
Max.wheel weight 最大车轮重量	2000kg
Max.wheel width 最大车轮宽度	1200mm
Max.tyre diameter 最大轮胎直径	2500mm
Hydraulic pump motor 液压动力单元	2.4/3.0 kw
Geatbox motor 齿轮箱电机	2.4/3.0 kw
Machine weight approx 设备净重	1145kg
Power 电压	400v 50HZ 3PH

WEIGHT&DIMENSIONS 重量&包装尺寸

Model	Gross Weight (kg)	Outside Dimension L×W×H (mm)
T980	1300	2310×2100×1100