

ZGSM-GCD160H

Introducing a New Premium Experience

Brighter
250W HID Replacement



Dimming functions are supported by optional
+ Three in One (1-10V DC or PWM Signal or Resistance)
+ Timer - Contact ZGSM for Details

Specifications

Electrical Specifications:

Model No.	ZGSM-GCD160H
Nominal Wattage	160W
Nominal Voltage	AC 100-240V /277V, 50/60Hz DC /
Maximum Current	AC 1.65A -120V, 0.82A -240V, 0.71A -277V DC /
Operating Temperature	-40 °C to +50 °C
Power Factor (PF)	> 0.9
Driver Efficiency	> 90%

Photometric Specifications:

Lumen Output	15200 lm (+/- 5%)
Photometric Type	60° 90° 110°
CRI	Minimum 70 CRI
CCT	<div style="display: flex; gap: 10px;"> <div style="border: 1px solid black; border-radius: 50%; padding: 2px 5px;">4000K</div> <div style="border: 1px solid black; border-radius: 50%; padding: 2px 5px;">5000K</div> <div style="border: 1px solid black; border-radius: 50%; padding: 2px 5px;">5700K</div> </div>

Mechanical Specifications:

Ratings	IP66, IK10
Lumen Maintenance	> 60,000 hours -L ₇₀ (9K), @25 °C (77 °F)
Heat Radiator	Anodized Aluminum
Lens	PC
Fixture Dimension	512 x340 x156 mm 20.2 x13.4 x6.1 inches
Fixture Weight	6.0 kg /13.2 lbs

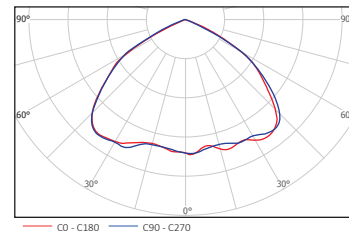
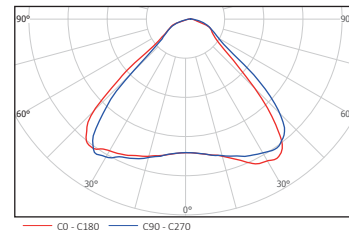
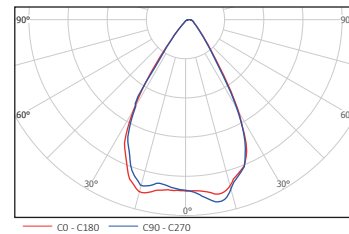
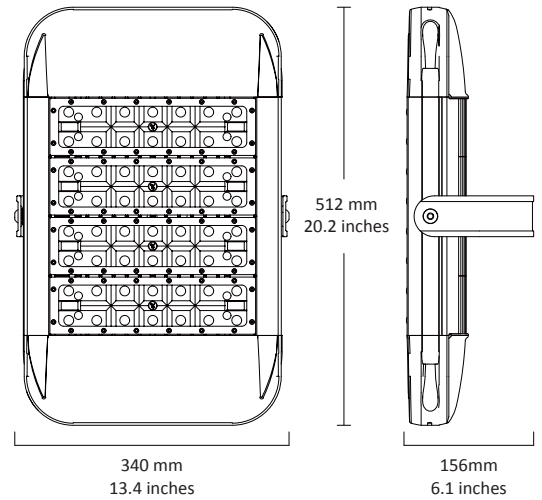

Packing Type

1 unit(s) /ctn.

Packing Dimension

560 x365 x160 mm
22.0 x14.4 x6.3 inches

Packing Weight

7.0 kg /15.4 lbs



CE RoHS CB

www.zgsm-china.com

