Product Specifications

NAME: Touch Panel 0-10V Output Dimmer

MODEL: E-TM016



Summarization

E-TM016 controller is a kind of 0-10V dimmer independent developed by our company, combined with wireless remote and touch dimming. With the glass panel design, beautiful, vogue appearance. Adopting high precision capacitance touch control chip, increases the touch sensitivity and reduces spurious triggering. Adopting wireless control function, increasing the control flexibility, the controller can also achieve two remote working with controller at the same time. It is convenient to use, adopt software to match code, and increase remote adaptation, offer more comfortable, safer, convenient intelligent lamps controlling effect than the traditional lamps controller. Optimizing feeling of the people to the lamp, bring a new and comfortable lighting environment.

Technical parameters

- working voltage: 90~240VAC/50~60Hz
- output voltage: 90~240VAC/50~60Hz
- output signal: 0-10V
- working temperature: -20-60°C
- working power consumption: < 3W
- external dimension: L86×W86×H36 mm
- packing size: L195×W155×H60mm
- net weight: 154g

- gross weight: 263g
- remote distance: < 20 meters
- output power: < 200W
- 0-10V output current :<15mA

External Dimension

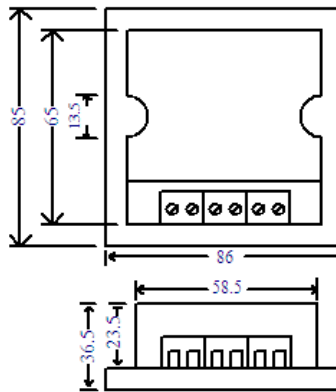

Interface Specifications

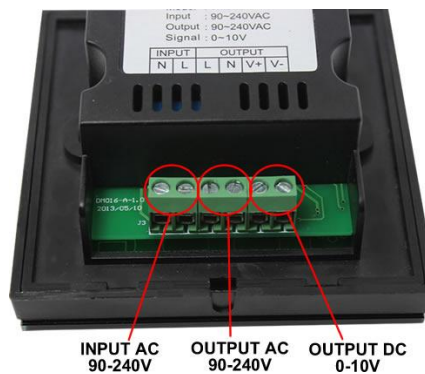

INPUT

L: Power input firing wire, the range of voltage is 90~240VAC, 50~60Hz;

N: Power input zero wire, the range of voltage is 90~240VAC, 50~60Hz;

OUTPUT

L: Relay output firing wire, (connecting fire interface of 0-10V dimmer power)output voltage is 90~240VAC, 50~60Hz;

N: Relay output zero wire, (connecting zero interface of 0-10V dimmer power) output voltage is 90~240VAC, 50~60Hz;

V+: output 0-10V signal anode;

V-: output 0-10V signal cathode;

Key Description:

This product has storage capabilities of four scenes, it could meet the applications of user's various

needs. According to their needs, user can set the output type of related scenes, when need to call any scene, you just need to press the scene that you set to call the scene, it is very convenient. This product has six buttons and one remote control, simple to operate, and easy to use. It adopts computer digital chips, with high reliability, accuracy, at the same time, it has function of long press and short press, can greatly reduce the misuse.



 : slide bar control: adjust brightness of lights, in the case of opening buzzer, each operation when let go, you can hear “di”, which means the operation is effective.

 : scene 1:

Long press: store the current scene, light is on; in the case of opening buzzer, “didi” of buzzer, that has been stored the current output voltage value, release your hand, the corresponding LED will light; if the buzzer is off, long press 5s, then you can release your hand, the corresponding LED will light.

Short press: switch to stored scene, the button indicator pressed will light, when buzzer is on, you can hear “di” of buzzer.

 scene 2:

Long press: store the current scene, light is on; in the case of opening buzzer, “didi” of buzzer, that has been stored the current output voltage value, release your hand, the corresponding LED will light; if the buzzer is off, long press 5s, then you can release your hand, the corresponding LED will light.

Short press: switch to stored scene, the button indicator pressed will light, when buzzer is on, you can hear “di” of buzzer.

 scene 3:

Long press: store the current scene, light is on; in the case of opening buzzer, “didi” of buzzer, that has been stored the current output voltage value, release your hand, the corresponding LED will light; if the buzzer is off, long press 5s, then you can release your hand, the corresponding LED will light.

Short press: switch to stored scene, the button indicator pressed will light, when buzzer is on, you can hear

“di” of buzzer.



scene 4:

Long press: store the current scene, light is on; in the case of opening buzzer, “didi” of buzzer, that has been stored the current output voltage value, release your hand, the corresponding LED will light; if the buzzer is off, long press 5s, then you can release your hand, the corresponding LED will light.

Short press: switch to stored scene, the button indicator pressed will light, when buzzer is on, you can hear “di” of buzzer.



On/off switch. When controller switch is turned on, the backlight is off, and restore to the state before off, at the moment, operations of other keys are effective, it can perform operation of all functions. Now, long press this key for more than 5s can open and close buzzer. When controller is turned off, the backlight will light up, it can not perform the above operation, can only perform on/off switch;

Descriptions of remote control key:



ON/OFF key, you can turn on/off dimmer at any state when power on; If the buzzer is open, the buzzer will zoom once in short time, 10 seconds before the power on, whatever the controller is on/off ,long press the key can match code.



Brightness increased key, in the state of starting up, every time short press this key, the brightness add 1 level, the brightness will increase rapidly with long press until 255;



Minus brightness key, in the state of starting up, every time short press this key, the brightness minus 1 level, the brightness will reduce rapidly with long press until 1;

Match code operate

The controller can achieve two remote working with controller at the same time. Within 10 seconds after power on, long press the ON/OFF key on remote control more than 3 seconds will be match code, for the first time match code successfully load light flashes three times, the second time match code successfully load lights flash 6 times, later each time match code will be replaced to remote in advance.

Typical Applications

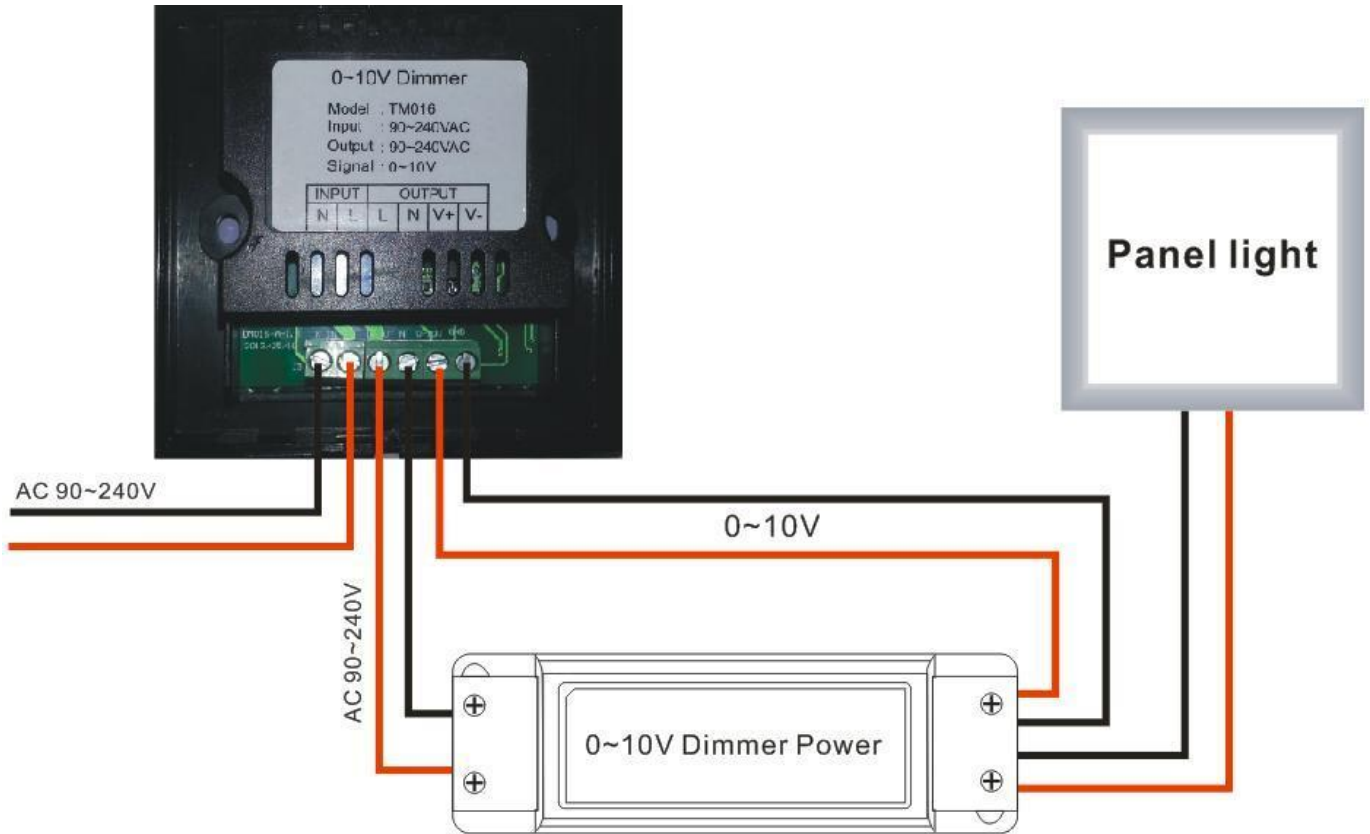

Installation Method

1. As shown in figure, use screwdriver to gently pry touch panel gaps, take the panel;



2. Fix the base of controller in the 86×86 installation box (customers need to buy the installation box by themselves) on the wall with screws, as shown in figure:

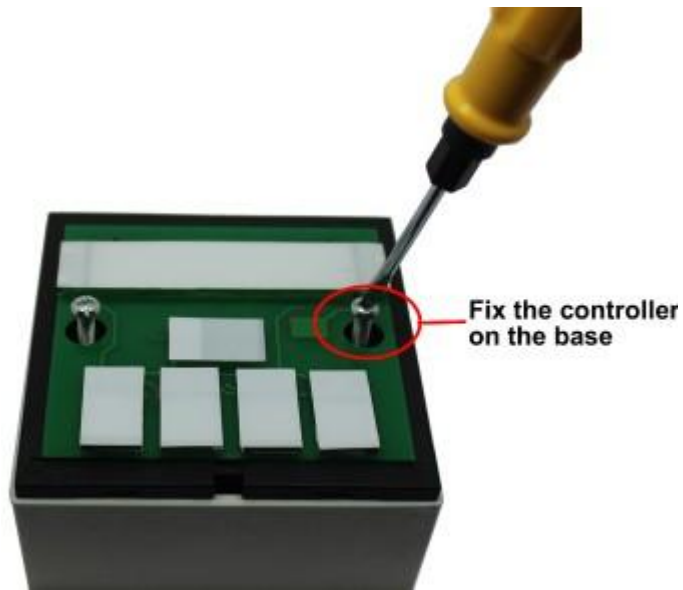

3. Place the glass panel on the installation box, until this, installation is completed, as shown below:



Notice

1. Please don't install controller in a seal off, high magnetic field;
2. Check out whether the supply voltage and power is in the range of controller required or not.
3. Before power on, please inspect if the line connection is correct, and test it whether there is a short circuit;
4. Any problem, please do not open the shell of controller, in case electronic shock.