

软管接头 HOSE FITTING

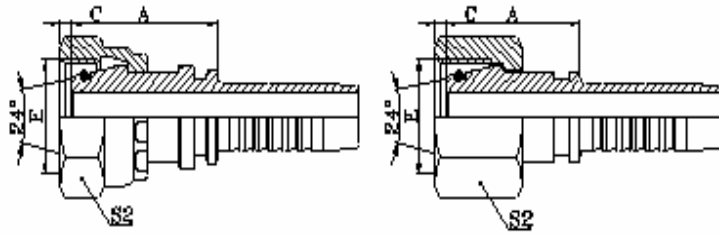

公制内螺纹 24°锥带 O 形圈轻系列
ISO 2151-2-DIN 3865
METRIC FEMALE 24° CONE O-RING L.T.

20411

20411-T

| 代 号 | 螺纹 E | 软 管 | | 管子外径 | O 形圈 | 尺 寸 | | |
|--------------|---------|------|-----|------|-----------|------|-----|----|
| | | 公称内径 | 标 号 | | | A | C | S2 |
| 20411-12-04 | M12X1.5 | 6 | 04 | 6 | O04.5X1.5 | 25 | 1 | 17 |
| 20411-14-04 | M14X1.5 | 6 | 04 | 8 | O06.5X1.5 | 26.5 | 2 | 19 |
| 20411-14-06 | M14X1.5 | 10 | 06 | 8 | O06.5X1.5 | 27.5 | 2 | 19 |
| 20411-16-04 | M16X1.5 | 6 | 04 | 10 | O08.0X1.5 | 27 | 2 | 22 |
| 20411-16-05 | M16X1.5 | 8 | 05 | 10 | O08.0X1.5 | 27 | 2 | 22 |
| 20411-16-06 | M16X1.5 | 10 | 06 | 10 | O08.0X1.5 | 28 | 2 | 22 |
| 20411-18-05T | M18X1.5 | 8 | 05 | 12 | O10.0X1.5 | 25.5 | 1.5 | 22 |
| 20411-18-06 | M18X1.5 | 10 | 06 | 12 | O10.0X1.5 | 29 | 2.5 | 24 |
| 20411-18-08 | M18X1.5 | 12 | 08 | 12 | O10.0X1.5 | 29.5 | 2.5 | 24 |
| 20411-22-05T | M22X1.5 | 8 | 05 | 15 | O12.0X2 | 26.5 | 3 | 27 |
| 20411-22-06T | M22X1.5 | 10 | 06 | 15 | O12.0X2 | 28.5 | 3 | 27 |
| 20411-22-08 | M22X1.5 | 12 | 08 | 15 | O12.0X2 | 32.5 | 2.5 | 27 |
| 20411-26-10 | M26X1.5 | 16 | 10 | 18 | O15.0X2 | 34.5 | 2.5 | 32 |
| 20411-26-12 | M26X1.5 | 20 | 12 | 18 | O15.0X2 | 34.5 | 2.5 | 32 |
| 20411-30-10T | M30X2 | 16 | 10 | 22 | O20.0X2 | 33 | 3.8 | 36 |
| 20411-30-12 | M30X2 | 20 | 12 | 22 | O20.0X2 | 36.5 | 4 | 36 |
| 20411-36-12T | M36X2 | 20 | 12 | 28 | O26.0X2 | 36 | 4.5 | 46 |
| 20411-36-14T | M36X2 | 22 | 14 | 28 | O26.0X2 | 36.5 | 4.5 | 46 |
| 20411-45-16T | M45X2 | 25 | 16 | 35 | O32.0X2 | 42 | 4 | 55 |
| 20411-45-20T | M45X2 | 32 | 20 | 35 | O32.0X2 | 43 | 4 | 55 |
| 20411-52-20T | M52X2 | 32 | 20 | 42 | O38.0X2 | 44.5 | 4 | 60 |
| 20411-52-24T | M52X2 | 40 | 24 | 42 | O38.0X2 | 44.5 | 4 | 60 |

注: 1.上述代号用于编织软管。 2. 如需用于缠绕软管代号改为 20412-xx-xx。

NOTE : 1. FOR USE WITH BRAIDED HOSES 2. IF USE WITH SPIRAL HOSES , HOSE FITTINGS SERIES NUMBER IS 20412-XX-XX.

软管接头 HOSE FITTING

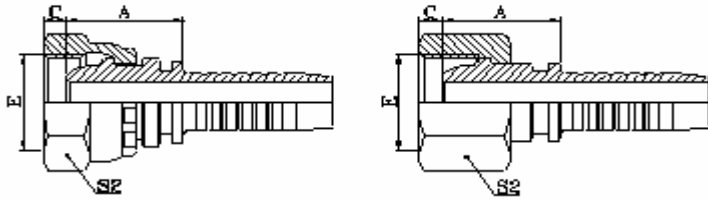

公制内螺纹球面

METRIC FEMALE MULTISEAL

20111

20111-T

| 代 号 | 螺纹 E | 软 管 | | 尺 寸 | | | |
|---------------|---------|------|-----|------|-----|----|--|
| | | 公称内径 | 标 号 | A | C | S2 | |
| 20111-10-03 | M10X1 | 5 | 03 | 18 | 2.5 | 14 | |
| 20111-10-04 | M10X1 | 6 | 04 | 18 | 2.5 | 14 | |
| 20111-12-04 | M12X1.5 | 6 | 04 | 18.5 | 4 | 17 | |
| 20111-12-05 | M12X1.5 | 8 | 05 | 18.5 | 4 | 17 | |
| 20111-14-04 | M14X1.5 | 6 | 04 | 20 | 4.5 | 19 | |
| 20111-14-05 | M14X1.5 | 8 | 05 | 19.5 | 4.5 | 19 | |
| 20111-16-04 | M16X1.5 | 6 | 04 | 20.5 | 4.5 | 22 | |
| 20111-16-05 | M16X1.5 | 8 | 05 | 20.5 | 4.5 | 22 | |
| 20111-16-06 | M16X1.5 | 10 | 06 | 20 | 4.5 | 22 | |
| 20111-18-05T | M18X1.5 | 8 | 05 | 21.5 | 4 | 24 | |
| 20111-18-06 | M18X1.5 | 10 | 06 | 22.5 | 4 | 24 | |
| 20111-18-08 | M18X1.5 | 12 | 08 | 22 | 4 | 24 | |
| 20111-20-06T | M20X1.5 | 10 | 06 | 23.5 | 5.5 | 24 | |
| 20111-20-08 | M20X1.5 | 12 | 08 | 23 | 5.5 | 27 | |
| 20111-22-06T | M22X1.5 | 10 | 06 | 23 | 5 | 27 | |
| 20111-22-08 | M22X1.5 | 12 | 08 | 24.5 | 5 | 27 | |
| 20111-22-10 | M22X1.5 | 16 | 10 | 24.5 | 5 | 27 | |
| 20111-24-08T | M24X1.5 | 12 | 08 | 22 | 5.5 | 30 | |
| 20111-24-10 | M24X1.5 | 16 | 10 | 26 | 5 | 30 | |
| 20111-27-08DT | M27X1.5 | 12 | 08 | 23 | 5.5 | 32 | |
| 20111-27-10DT | M27X1.5 | 16 | 10 | 26 | 5.5 | 32 | |
| 20111-27-12D | M27X1.5 | 20 | 12 | 26 | 5.5 | 32 | |
| 20111-27-10T | M27X2 | 16 | 10 | 26 | 7 | 32 | |
| 20111-30-12D | M30X1.5 | 20 | 12 | 26.5 | 6 | 36 | |
| 20111-30-12 | M30X2 | 20 | 12 | 26 | 7 | 36 | |
| 20111-36-12T | M36X2 | 20 | 12 | 26 | 7 | 41 | |
| 20111-36-14T | M36X2 | 22 | 14 | 26 | 7 | 41 | |
| 20111-39-14T | M39X2 | 22 | 14 | 28.5 | 7 | 46 | |
| 20111-39-16T | M39X2 | 25 | 16 | 34 | 7 | 46 | |
| 20111-42-16T | M42X2 | 25 | 16 | 30 | 8.5 | 50 | |
| 20111-45-20T | M45X2 | 32 | 20 | 31.5 | 8.5 | 55 | |
| 20111-52-20T | M52X2 | 32 | 20 | 33 | 9 | 60 | |
| 20111-52-24T | M52X2 | 40 | 24 | 33 | 9 | 60 | |
| 20111-64-32T | M64X2 | 50 | 32 | 35 | 14 | 75 | |

注: 1. 上述代号用于编织软管。 2. 如需用于缠绕软管代号改为 20112-xx-xx。

NOTE : 1. FOR USE WITH BRAIDED HOSES 2. IF USE WITH SPIRAL HOSES , HOSE FITTINGS SERIES NUMBER IS 20112-XX-XX.

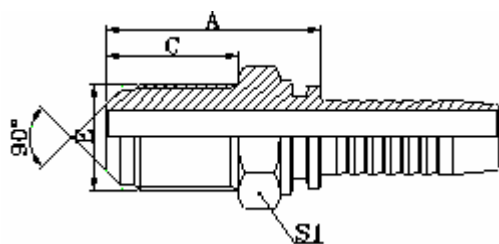

10811L

公制外螺纹 90° 外锥面

METRIC MALE 90°CONE

| 代 号 | 螺 纹 E | 软 管 | | 尺 寸 | | | |
|---------------|---------|------|-----|------|------|----|----|
| | | 公称内径 | 标 号 | A | C | H | S2 |
| 10811L-12-04 | M12X1.5 | 6 | 04 | 46 | 34 | 17 | 17 |
| 10811L-12-04A | M12X1 | 6 | 04 | 44.5 | 32.5 | 17 | 17 |
| 10811L-14-04 | M14X1.5 | 6 | 04 | 46 | 34 | 17 | 19 |
| 10811L-14-06 | M14X1.5 | 10 | 06 | 46.5 | 34 | 17 | 19 |
| 10811L-16-04 | M16X1.5 | 6 | 04 | 46.5 | 34 | 19 | 22 |
| 10811L-16-06 | M16X1.5 | 10 | 06 | 46.5 | 34 | 22 | 22 |
| 10811L-20-06 | M20X1.5 | 10 | 06 | 57 | 40 | 27 | 27 |
| 10811L-20-08 | M20X1.5 | 12 | 08 | 57.5 | 40 | 27 | 27 |
| 10811L-22-08 | M22X1.5 | 12 | 08 | 62.5 | 45 | 27 | 27 |

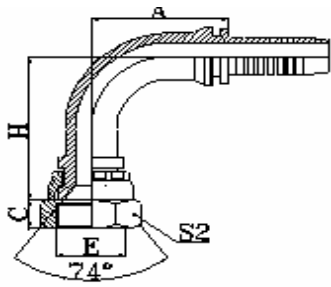

20791

90° 国际公制内螺纹 74° 内锥面
90°METRIC FEMALE 74°CONE SEAT

| 代 号 | 螺纹 E | 软 管 | | 尺 寸 | | | |
|--------------|----------|------|-----|-------|-----|------|----|
| | | 公称内径 | 标 号 | A | C | H | S2 |
| 20791-12-04C | M12X1.25 | 6 | 04 | 30 | 9 | 33.5 | 17 |
| 20791-12-04 | M12X1.5 | 6 | 04 | 30 | 10 | 33.5 | 17 |
| 20791-14-04 | M14X1.5 | 6 | 04 | 27.5 | 8.5 | 34 | 19 |
| 20791-16-04 | M16X1.5 | 6 | 04 | 30 | 8 | 35 | 22 |
| 20791-16-05 | M16X1.5 | 8 | 05 | 31 | 8 | 39.5 | 22 |
| 20791-18-06 | M18X1.5 | 10 | 06 | 33 | 10 | 42 | 24 |
| 20791-22-08 | M22X1.5 | 12 | 08 | 42.5 | 10 | 49.5 | 27 |
| 20791-22-10 | M22X1.5 | 16 | 10 | 56 | 10 | 52.5 | 27 |
| 20791-27-10 | M27X1.5 | 16 | 10 | 48.5 | 11 | 54.5 | 32 |
| 20791-30-12 | M30X1.5 | 20 | 12 | 50.5 | 11 | 63.5 | 36 |
| 20791-33-12 | M33X2 | 20 | 12 | 65.5 | 13 | 63.5 | 41 |
| 20791-33-16 | M33X2 | 25 | 16 | 66 | 13 | 75.5 | 41 |
| 20791-36-12 | M36X2 | 20 | 12 | 65.5 | 124 | 63.5 | 41 |
| 20791-36-14 | M36X2 | 22 | 14 | 71.2 | 14 | 64.5 | 41 |
| 20791-39-16 | M39X2 | 25 | 16 | 66 | 14 | 76.5 | 46 |
| 20791-45-20W | M45X2 | 32 | 20 | 91.5 | 15 | 83 | 55 |
| 20791-52-20W | M52X2 | 32 | 20 | 93 | 17 | 84.5 | 60 |
| 20791-52-24W | M52X1.5 | 40 | 24 | 110.7 | 17 | 96.5 | 60 |

注: 1.上述代号用于编织软管。 2. 如需用于缠绕软管代号改为 20792-xx-xx。

NOTE : 1. FOR USE WITH BRAIDED HOSES 2. IF USE WITH SPIRAL HOSES , HOSE FITTINGS SERIES NUMBER IS 20792-XX-XX.

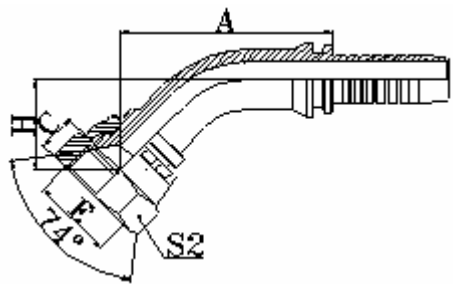

20741
45° 国际公制内螺纹 74° 内锥面
45°METRIC FEMALE 74°CONE SEAT

| 代 号 | 螺纹 E | 软 管 | | 尺 寸 | | | |
|--------------|---------|------|-----|-------|-----|------|----|
| | | 公称内径 | 标 号 | A | C | H | S2 |
| 20741-14-04 | M14X1.5 | 6 | 04 | 38 | 8.5 | 19 | 19 |
| 20741-16-05 | M16X1.5 | 8 | 05 | 42.3 | 8 | 20.7 | 22 |
| 20741-18-06 | M18X1.5 | 10 | 06 | 45.5 | 10 | 22 | 24 |
| 20741-22-08 | M22X1.5 | 12 | 08 | 57.5 | 10 | 24.5 | 27 |
| 20741-27-10 | M27X1.5 | 16 | 10 | 60 | 11 | 26.5 | 32 |
| 20741-30-12 | M30X1.5 | 20 | 12 | 74 | 11 | 30 | 36 |
| 20741-33-12 | M33X2 | 20 | 12 | 77.4 | 13 | 30 | 41 |
| 20741-33-16 | M33X2 | 25 | 16 | 85 | 13 | 30.8 | 41 |
| 20741-36-14 | M36X2 | 22 | 14 | 79.8 | 14 | 29.6 | 4 |
| 20741-36-16 | M36X2 | 25 | 16 | 85.7 | 14 | 31.5 | 41 |
| 20741-39-16 | M39X2 | 25 | 16 | 85 | 14 | 33 | 46 |
| 20741-45-20W | M45X2 | 32 | 20 | 97 | 15 | 36.2 | 55 |
| 20741-52-24W | M52X2 | 40 | 24 | 115.3 | 17 | 40.9 | 60 |

注: 1.上述代号用于编织软管。 2. 如需用于缠绕软管代号改为 20742-xx-xx。

NOTE : 1. FOR USE WITH BRAIDED HOSES 2. IF USE WITH SPIRAL HOSES , HOSE FITTINGS SERIES NUMBER IS 20742-XX-XX.

软管接头 HOSE FITTING

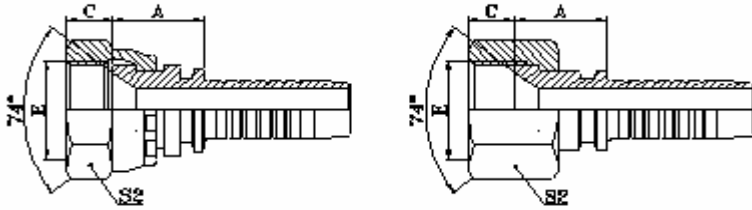

国际公制内螺纹 74° 内锥
METRIC FEMALE 74° CONE SEAT

20711

20711-T

| 代 号 | 螺纹 E | 软 管 | | 尺 寸 | | | |
|--------------|----------|------|-----|------|-----|----|--|
| | | 公称内径 | 标 号 | A | C | S2 | |
| 20711-10-02 | M10X1 | 4 | 02 | 14 | 7.5 | 14 | |
| 20711-12-03C | M12X1.25 | 5 | 03 | 14 | 9 | 17 | |
| 20711-12-03 | M12X1.5 | 5 | 03 | 14 | 10 | 17 | |
| 20711-12-04 | M12X1.5 | 6 | 04 | 15 | 10 | 17 | |
| 20711-14-04 | M14X1.5 | 6 | 04 | 16 | 8.5 | 19 | |
| 20711-14-05 | M14X1.5 | 8 | 05 | 15.5 | 8.5 | 19 | |
| 20711-14-06 | M14X1.5 | 10 | 06 | 15.5 | 8.5 | 19 | |
| 20711-16-04 | M16X1.5 | 6 | 04 | 16.5 | 8 | 22 | |
| 20711-16-05 | M16X1.5 | 8 | 05 | 17 | 8 | 22 | |
| 20711-16-06 | M16X1.5 | 10 | 06 | 16 | 8 | 22 | |
| 20711-18-05T | M18X1.5 | 8 | 05 | 16 | 8 | 22 | |
| 20711-18-06 | M18X1.5 | 10 | 06 | 18.5 | 10 | 24 | |
| 20711-20-06T | M20X1.5 | 10 | 06 | 16 | 10 | 24 | |
| 20711-20-08 | M20X1.5 | 12 | 08 | 18.5 | 10 | 27 | |
| 20711-22-06T | M22X1.5 | 10 | 06 | 16 | 10 | 27 | |
| 20711-22-08 | M22X1.5 | 12 | 08 | 19.5 | 10 | 27 | |
| 20711-22-10 | M22X1.5 | 16 | 10 | 19 | 10 | 27 | |
| 20711-24-08T | M24X1.5 | 12 | 08 | 16.5 | 11 | 30 | |
| 20711-27-08T | M27X1.5 | 12 | 08 | 18.5 | 11 | 32 | |
| 20711-27-10T | M27X1.5 | 16 | 10 | 21 | 11 | 32 | |
| 20711-27-12 | M27X1.5 | 20 | 12 | 21.5 | 11 | 32 | |
| 20711-30-10T | M30X1.5 | 16 | 10 | 18 | 11 | 36 | |
| 20711-30-12 | M30X1.5 | 20 | 12 | 22 | 11 | 36 | |
| 20711-33-10T | M33X2 | 16 | 10 | 19.5 | 13 | 41 | |
| 20711-33-12T | M33X2 | 20 | 12 | 20 | 13 | 41 | |
| 20711-33-14 | M33X2 | 22 | 14 | 21.5 | 13 | 41 | |
| 20711-36-12T | M36X2 | 20 | 12 | 20 | 14 | 41 | |
| 20711-36-14T | M36X2 | 22 | 14 | 24 | 14 | 41 | |
| 20711-36-16 | M36X2 | 25 | 16 | 23 | 14 | 41 | |
| 20711-39-16T | M39X2 | 25 | 16 | 25 | 14 | 46 | |
| 20711-42-16T | M42X2 | 25 | 16 | 23.5 | 15 | 50 | |
| 20711-42-20W | M42X2 | 32 | 20 | 24.5 | 15 | 50 | |
| 20711-45-20T | M45X2 | 32 | 20 | 27 | 15 | 55 | |
| 20711-52-24T | M52X2 | 40 | 24 | 27 | 17 | 60 | |

注: 1. 上述代号用于编织软管。 2. 如需用于缠绕软管代号改为 20712-xx-xx。

NOTE : 1. FOR USE WITH BRAIDED HOSES 2. IF USE WITH SPIRAL HOSES , HOSE FITTINGS SERIES NUMBER IS 20712-XX-XX.

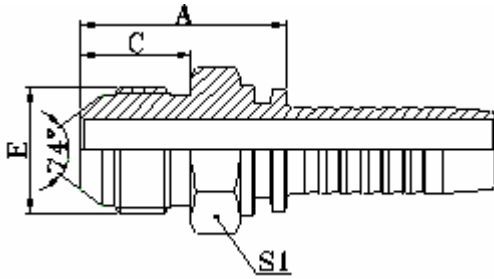

10711

国际公制外螺纹 74° 外锥面

METRIC MALE 74° CONE

| 代 号 | 螺纹 E | 软 管 | | 尺 寸 | | | |
|--------------|----------|------|-----|------|------|----|--|
| | | 公称内径 | 标 号 | A | C | S1 | |
| 10711-10-02 | M10X1 | 4 | 02 | 23 | 12.5 | 14 | |
| 10711-10-03 | M10X1 | 5 | 03 | 23 | 12.5 | 14 | |
| 10711-12-03 | M12X1.5 | 5 | 03 | 26.5 | 15.7 | 14 | |
| 10711-12-03C | M12X1.25 | 5 | 03 | 24.5 | 14 | 14 | |
| 10711-14-04 | M14X1.5 | 6 | 04 | 30.5 | 18 | 17 | |
| 10711-14-06 | M14X1.5 | 10 | 06 | 30.5 | 18 | 17 | |
| 10711-16-05 | M16X1.5 | 8 | 05 | 31.5 | 19 | 17 | |
| 10711-16-06 | M16X1.5 | 10 | 06 | 31.5 | 19 | 17 | |
| 10711-18-06 | M18X1.5 | 10 | 06 | 32 | 19 | 19 | |
| 10711-22-08 | M22X1.5 | 12 | 08 | 34.5 | 19.5 | 24 | |
| 10711-24-08 | M24X1.5 | 12 | 08 | 36.5 | 20 | 27 | |
| 10711-27-10 | M27X1.5 | 16 | 10 | 39 | 20.5 | 30 | |
| 10711-30-12 | M30X2 | 20 | 12 | 42.5 | 23 | 32 | |
| 10711-30-12E | M30X2 | 20 | 12 | 45.5 | 26 | 32 | |
| 10711-33-12 | M33X2 | 20 | 12 | 46.5 | 26 | 36 | |
| 10711-36-14 | M36X2 | 22 | 14 | 47 | 26 | 38 | |
| 10711-39-16 | M39X2 | 25 | 16 | 50 | 27.5 | 41 | |
| 10711-42-20 | M42X2 | 32 | 20 | 52.5 | 28.5 | 46 | |
| 10711-45-20 | M45X2 | 32 | 20 | 52.5 | 28.5 | 46 | |

注: 1.上述代号用于编织软管。 2. 如需用于缠绕软管代号改为 10712-xx-xx。

NOTE : 1. FOR USE WITH BRAIDED HOSES 2. IF USE WITH SPIRAL HOSES , HOSE FITTINGS SERIES NUMBER IS10712-XX-XX.

软管接头 HOSE FITTING

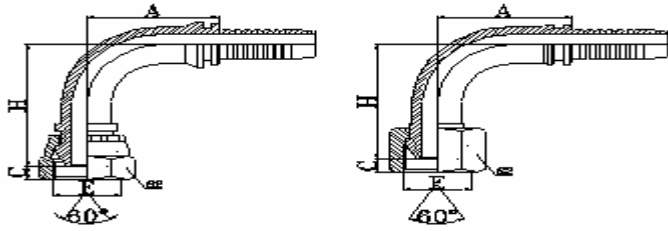

90° 公制外内螺纹 60° 外锥面
90°METRIC FEMALE 60°CONE

20691

20691-T

| 代 号 | 螺纹 E | 软 管 | | 尺 寸 | | | |
|---------------|---------|------|-----|-------|-----|------|----|
| | | 公称内径 | 标 号 | A | C | H | S2 |
| 20611-14-04 | M14X1.5 | 6 | 04 | 27.5 | 5.5 | 37 | 19 |
| 20611-16-05 | M16X1.5 | 8 | 05 | 31 | 5.5 | 42 | 22 |
| 20611-18-06 | M18X1.5 | 10 | 06 | 33 | 5.5 | 44.5 | 24 |
| 20611-22-08 | M22X1.5 | 12 | 08 | 42.5 | 6 | 53.5 | 27 |
| 20611-27-10DT | M27X1.5 | 16 | 10 | 56 | 6 | 55 | 32 |
| 20611-30-12D | M30X2 | 20 | 12 | 66.2 | 6 | 68.5 | 36 |
| 20611-36-16 | M36X2 | 25 | 16 | 78 | 6.5 | 76.5 | 41 |
| 20611-36-14T | M36X2 | 22 | 14 | 71.2 | 6.5 | 67.5 | 41 |
| 20611-39-16T | M39X2 | 25 | 16 | 76.7 | 6.5 | 74 | 46 |
| 20611-45-20T | M45X2 | 32 | 20 | 91.5 | 8.5 | 85 | 55 |
| 20611-52-24T | M52X2 | 40 | 24 | 109.4 | 10 | 99 | 60 |

注: 1.上述代号用于编织软管。 2. 如需用于缠绕软管代号改为 20692-xx-xx。

NOTE : 1. FOR USE WITH BRAIDED HOSES 2. IF USE WITH SPIRAL HOSES , HOSE FITTINGS SERIES NUMBER IS20692-XX-XX.

软管接头 HOSE FITTING

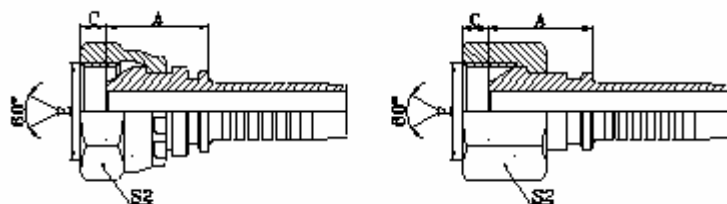

公制外内螺纹 60°
METRIC FEMALE 60°CONE

20611

20611-T

| 代 号 | 螺纹 E | 软 管 | | 尺 寸 | | | |
|---------------|---------|------|-----|------|-----|----|--|
| | | 公称内径 | 标 号 | A | C | S2 | |
| 20611-14-04 | M14X1.5 | 6 | 04 | 19 | 5.5 | 19 | |
| 20611-16-05 | M16X1.5 | 8 | 05 | 19.5 | 5.5 | 22 | |
| 20611-16-06 | M16X1.5 | 10 | 06 | 19 | 5.5 | 22 | |
| 20611-18-06 | M18X1.5 | 10 | 06 | 21 | 5.5 | 24 | |
| 20611-20-08 | M20X1.5 | 12 | 08 | 22 | 6.5 | 27 | |
| 20611-22-08 | M22X1.5 | 12 | 08 | 23.5 | 6 | 27 | |
| 20611-24-10 | M24X1.5 | 16 | 10 | 24.5 | 6.5 | 30 | |
| 20611-26-10 | M26X1.5 | 16 | 10 | 25 | 6 | 32 | |
| 20611-27-10DT | M27X1.5 | 16 | 10 | 25.5 | 6 | 32 | |
| 20611-27-10T | M27X1.5 | 16 | 10 | 25.5 | 6 | 32 | |
| 20611-30-10D | M30X2 | 16 | 10 | 26.5 | 6 | 36 | |
| 20611-30-12D | M30X2 | 20 | 12 | 26.5 | 6 | 36 | |
| 20611-30-12 | M30X2 | 20 | 12 | 27 | 6 | 36 | |
| 20611-36-16 | M36X2 | 25 | 16 | 30 | 6.5 | 41 | |
| 20611-39-16T | M39X2 | 25 | 16 | 30 | 6.5 | 46 | |
| 20611-45-20T | M45X2 | 32 | 20 | 31 | 8.5 | 55 | |
| 20611-52-24T | M52X2 | 40 | 24 | 32 | 10 | 60 | |

注: 1.上述代号用于编织软管。 2. 如需用于缠绕软管代号改为 20612-xx-xx。

NOTE : 1. FOR USE WITH BRAIDED HOSES 2. IF USE WITH SPIRAL HOSES , HOSE FITTINGS SERIES NUMBER IS20612-XX-XX.

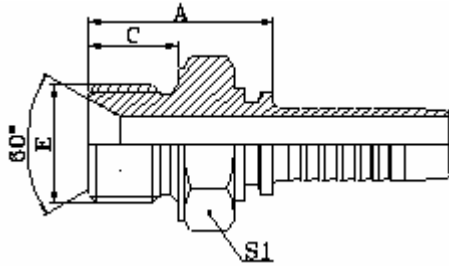

10611

公制外螺纹 60° 内锥面或六角编面
用组合垫密封的双用接头

METRIC MALE DOUBLE USE FOR 60°

| 代 号 | 螺纹 E | 软 管 | | 尺 寸 | | | |
|--------------|---------|------|-----|------|----|----|--|
| | | 公称内径 | 标 号 | A | C | S1 | |
| 10611-14-04 | M14X1.5 | 6 | 04 | 23.5 | 11 | 19 | |
| 10611-14-06 | M14X1.5 | 10 | 06 | 25 | 11 | 19 | |
| 10611-16-04 | M16X1.5 | 6 | 04 | 27.5 | 12 | 22 | |
| 10611-16-05 | M16X1.5 | 8 | 05 | 27.5 | 12 | 22 | |
| 10611-18-06 | M18X1.5 | 10 | 06 | 29.5 | 12 | 24 | |
| 10611-22-06 | M22X1.5 | 10 | 06 | 30.5 | 14 | 27 | |
| 10611-22-08 | M22X1.5 | 12 | 08 | 31 | 14 | 27 | |
| 10611-24-10 | M24X1.5 | 16 | 10 | 35 | 14 | 30 | |
| 10611-26-10 | M26X1.5 | 16 | 10 | 35 | 16 | 32 | |
| 10611-27-10D | M27X1.5 | 16 | 10 | 35 | 16 | 32 | |
| 10611-27-10 | M27X1.5 | 16 | 10 | 37 | 18 | 32 | |
| 10611-30-12D | M30X2 | 20 | 12 | 38 | 18 | 36 | |
| 10611-30-12 | M30X2 | 20 | 12 | 38 | 18 | 36 | |
| 10611-33-16 | M33X2 | 25 | 16 | 43 | 20 | 46 | |
| 10611-42-20 | M42X2 | 32 | 20 | 46 | 20 | 50 | |
| 10611-45-20 | M45X2 | 32 | 20 | 46 | 20 | 55 | |
| 10611-48-24 | M48X2 | 40 | 24 | 46 | 20 | 55 | |
| 10611-52-24 | M52X2 | 40 | 24 | 46 | 20 | 60 | |

注: 1.上述代号用于编织软管。 2. 如需用于缠绕软管代号改为 10612xx-xx。

NOTE : 1. FOR USE WITH BRAIDED HOSES 2. IF USE WITH SPIRAL HOSES , HOSE FITTINGS SERIES NUMBER IS 10612-XX-XX.

20591C 20591C-T

90° 公制内螺纹 24° 球面重系列
90° METRIC FEMALE 24° MULTISEAL H.T.

| 代 号 | 螺 纹 E | 软 管 | | 管子外径 | 尺 寸 | | | |
|---------------|---------|------|-----|------|------|-----|------|----|
| | | 公称内径 | 标 号 | | A | C | H | S2 |
| 20591C-16-04 | M16X1.5 | 6 | 04 | 8 | 30 | 3 | 40 | 22 |
| 20591C-18-04T | M18X1.5 | 6 | 04 | 10 | 30 | 3 | 38.5 | 22 |
| 20591C-20-05T | M20X1.5 | 8 | 05 | 12 | 33 | 4.5 | 42 | 24 |
| 20591C-20-06T | M20X1.5 | 10 | 06 | 12 | 35.3 | 4.5 | 45.7 | 24 |
| 20591C-22-06T | M22X1.5 | 10 | 06 | 14 | 35.3 | 4.5 | 44.7 | 27 |
| 20591C-24-08T | M24X1.5 | 12 | 08 | 16 | 41 | 5 | 52 | 30 |
| 20591C-30-10T | M30X2 | 16 | 10 | 20 | 56.5 | 7 | 56.5 | 36 |
| 20591C-36-12T | M36X2 | 20 | 12 | 25 | 65.5 | 6.5 | 66.5 | 41 |
| 20591C-42-16T | M42X2 | 25 | 16 | 30 | 78 | 9 | 73.5 | 50 |
| 20591C-52-20T | M52X2 | 32 | 20 | 38 | 93 | 8 | 87.5 | 60 |

注: 1.上述代号用于编织软管。 2. 如需用于缠绕软管代号改为 20592C-xx-xx。

NOTE : 1. FOR USE WITH BRAIDED HOSES 2. IF USE WITH SPIRAL HOSES , HOSE FITTINGS SERIES NUMBER IS20592C-XX-XX.

软管接头 HOSE FITTING

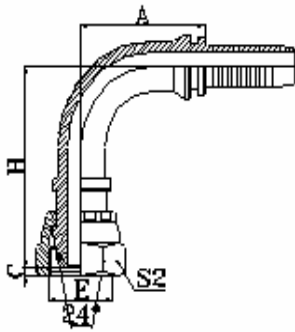

20591

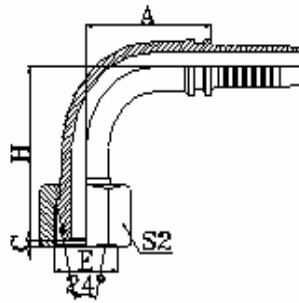

20591-T

90° 公制内螺纹
 24° 锥带 O 形圈重系列
 ISO 12151-2-DIN 3865
 90°METRIC FEMALE 24°CONE
 O-RING H.T.

| 代 号 | 螺纹 E | 软 管 | | 管子外径 | O 形圈 | 尺 寸 | | | |
|--------------|---------|------|-----|------|-----------|------|-----|-------|--------|
| | | 公称内径 | 标 号 | | | A | C | H | S 2 |
| 20591-14-04 | M16X1.5 | 6 | 04 | 6 | O04.5X1.5 | 27.5 | 1.5 | 45.4 | 19 |
| 20591-16-04 | M16X1.5 | 6 | 04 | 8 | O06.5X1.5 | 27.5 | 1.5 | 45.5 | 22 |
| 20591-16-05 | M16X1.5 | 8 | 05 | 8 | O06.5X1.5 | 31 | 1.5 | 50 | 22 |
| 20591-18-05T | M18X1.5 | 8 | 05 | 10 | O08.0X1.5 | 31 | 1.5 | 43.5 | 22 |
| 20591-18-06 | M18X1.5 | 10 | 06 | 10 | O08.0X1.5 | 33 | 2 | 53 | 24 |
| 20591-20-06T | M20X1.5 | 10 | 06 | 12 | O10.0X1.5 | 33 | 2.5 | 46.5 | 24 |
| 20591-20-08 | M20X1.5 | 12 | 08 | 12 | O10.0X1.5 | 42.5 | 2.5 | 61.5 | 27 |
| 20591-22-06T | M22X1.5 | 10 | 06 | 14 | O11.0X2.0 | 33 | 3 | 47 | 27 |
| 20591-22-08 | M22X1.5 | 12 | 08 | 14 | O11.0X2.0 | 42.5 | 2.5 | 62.5 | 27 |
| 20591-24-08T | M24X1.5 | 12 | 08 | 16 | O13.0X2.0 | 42.5 | 3 | 55 | 30 |
| 20591-24-10 | M24X1.5 | 16 | 10 | 16 | O13.0X2.0 | 48.5 | 2.5 | 68 | 30 |
| 20591-30-10T | M30X2 | 16 | 10 | 20 | O16.3X2.4 | 48.5 | 2.5 | 60.5 | 36 |
| 20591-30-12 | M30X2 | 20 | 12 | 20 | O16.3X2.4 | 50.5 | 3 | 78.5 | 36 |
| 20591-36-12T | M36X2 | 20 | 12 | 25 | O20.3X2.4 | 50.5 | 3.2 | 72 | 46 |
| 20591-36-14T | M36X2 | 22 | 14 | 25 | O20.3X2.4 | 57.5 | 3.2 | 74 | 46 |
| 20591-42-16T | M42X2 | 25 | 16 | 30 | O25.3X2.4 | 66 | 3.9 | 83 | 50 |
| 20591-52-20T | M52X2 | 32 | 20 | 38 | O33.3X2.4 | 75 | 4.5 | 95.5 | 60 |
| 20591-52-24T | M52X2 | 40 | 24 | 38 | O33.3X2.4 | 93 | 4.5 | 107.5 | 60 |

注: 1. 上述代号用于编织软管。 2. 如需用于缠绕软管代号改为 20592-xx-xx。

NOTE : 1. FOR USE WITH BRAIDED HOSES 2. IF USE WITH SPIRAL HOSES , HOSE FITTINGS SERIES NUMBER IS 20592-XX-XX.

20541C

20541C-T

45° 公制内螺纹 24° 球面系列 DIN3868
45° METRIC FEMALE 24° MULTISEAL H.T.

| 代 号 | 螺 纹 E | 软 管 | | 管子外径 | 尺 寸 | | | |
|---------------|---------|------|-----|------|------|-----|------|----|
| | | 公称内径 | 标 号 | | A | C | H | S2 |
| 20541C-16-04 | M16X1.5 | 6 | 04 | 8 | 44.8 | 3 | 22.7 | 19 |
| 20541C-18-04T | M18X1.5 | 6 | 04 | 10 | 43.7 | 3 | 21.6 | 22 |
| 20541C-20-06T | M20X1.5 | 10 | 06 | 12 | 48.9 | 4.5 | 24.6 | 24 |
| 20541C-24-08T | M24X1.5 | 12 | 08 | 16 | 61.4 | 2.5 | 26.5 | 30 |

注: 1.上述代号用于编织软管。 2. 如需用于缠绕软管代号改为 20542C_{xx-xx}。

NOTE : 1. FOR USE WITH BRAIDED HOSES 2. IF USE WITH SPIRAL HOSES , HOSE FITTINGS SERIES NUMBER IS20542C-XX-XX.

软管接头 HOSE FITTING

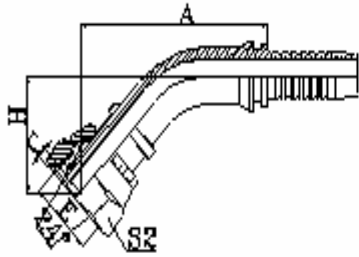

20541

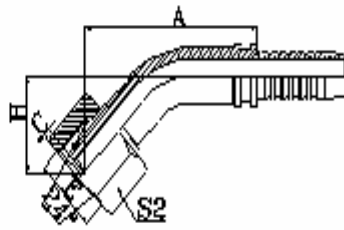

20541-T

45° 公制内螺纹
 24° 锥带 O 形圈重系列
 ISO 12151-2-DIN
 45° METRIC FEMALE
 24° CONE O-RING H.T.

| 代 号 | 螺纹 E | 软 管 | | 管子外径 | O 形圈 | 尺 寸 | | | |
|--------------|---------|------|-----|------|-----------|------|-----|------|----|
| | | 公称内径 | 标 号 | | | A | C | H | S2 |
| 20541-14-04 | M16X1.5 | 6 | 04 | 6 | O04.5X1.5 | 46 | 1.5 | 27 | 19 |
| 20541-16-04 | M16X1.5 | 6 | 04 | 8 | O06.5X1.5 | 46 | 1.5 | 27 | 22 |
| 20541-16-05 | M16X1.5 | 8 | 05 | 8 | O06.5X1.5 | 49.5 | 1.5 | 28.1 | 22 |
| 20541-18-04T | M18X1.5 | 6 | 04 | 10 | O08.0X1.5 | 41.5 | 1.5 | 22.5 | 22 |
| 20541-18-06 | M18X1.5 | 10 | 06 | 10 | O08.0X1.5 | 53 | 2 | 29.5 | 24 |
| 20541-20-06T | M20X1.5 | 10 | 06 | 12 | O10.0X1.5 | 48.5 | 2.5 | 25 | 24 |
| 20541-20-08 | M20X1.5 | 12 | 08 | 12 | O10.0X1.5 | 65.9 | 2.5 | 33 | 27 |
| 20541-22-06T | M22X1.5 | 10 | 06 | 14 | O11.0X2.0 | 48.9 | 3 | 25.3 | 27 |
| 20541-22-08 | M22X1.5 | 12 | 08 | 14 | O11.0X2.0 | 66.5 | 2.5 | 34 | 27 |
| 20541-24-08T | M24X1.5 | 12 | 08 | 16 | O13.0X2.0 | 61.3 | 3 | 28.5 | 30 |
| 20541-30-10T | M30X2 | 16 | 10 | 20 | O16.3X2.4 | 64.5 | 2.5 | 30.8 | 36 |
| 20541-30-12 | M30X2 | 20 | 12 | 20 | O16.3X2.4 | 84.5 | 3 | 41 | 36 |
| 20541-36-12T | M36X2 | 20 | 12 | 25 | O20.3X2.4 | 80 | 3.2 | 36 | 46 |
| 20541-36-14T | M36X2 | 22 | 14 | 25 | O20.3X2.4 | | 3.2 | | 46 |
| 20541-42-16T | M42X2 | 25 | 16 | 30 | O25.3X2.4 | 89.4 | 3.9 | 37.5 | 50 |
| 20541-52-20T | M52X2 | 32 | 20 | 38 | O33.3X2.4 | 102 | 4.5 | 42.8 | 60 |
| 20541-52-24T | M52X2 | 40 | 24 | 38 | O33.3X2.4 | | 4.5 | | 60 |

注: 1.上述代号用于编织软管。 2. 如需用于缠绕软管代号改为 20542-xx-xx。

NOTE : 1. FOR USE WITH BRAIDED HOSES 2. IF USE WITH SPIRAL HOSES , HOSE FITTINGS SERIES NUMBER IS20542-XX-XX.

20511C 20511C-T

公制内螺纹 24° 球面重系列
METRIC FEMALE 24° MULTISEAL H.T.

| 代 号 | 螺 纹 E | 软 管 | | 管子外径 | 尺 寸 | | | |
|---------------|---------|------|-----|------|------|-----|----|--|
| | | 公称内径 | 标 号 | | A | C | S2 | |
| 20511C-18-04T | M18X1.5 | 6 | 04 | 10 | 21 | 3 | 22 | |
| 20511C-20-05T | M20X1.5 | 8 | 05 | 12 | 21.5 | 4.5 | 24 | |
| 20511C-20-06T | M20X1.5 | 10 | 06 | 12 | 21.5 | 4.5 | 24 | |
| 20511C-22-06T | M22X1.5 | 10 | 06 | 14 | 21.5 | 4.5 | 27 | |
| 20511C-24-08T | M24X1.5 | 12 | 08 | 16 | 23 | 5 | 30 | |
| 20511C-30-10T | M30X2 | 16 | 10 | 20 | 26.5 | 7 | 36 | |
| 20511C-36-12T | M36X2 | 20 | 12 | 25 | 27 | 6.5 | 41 | |
| 20511C-42-16T | M42X2 | 25 | 16 | 30 | 29.5 | 9 | 50 | |
| 20511C-52-20T | M52X2 | 32 | 20 | 38 | 34 | 8 | 60 | |

注: 1.上述代号用于编织软管。 2. 如需用于缠绕软管代号改为 20512C-xx-xx。

NOTE : 1. FOR USE WITH BRAIDED HOSES 2. IF USE WITH SPIRAL HOSES , HOSE FITTINGS SERIES NUMBER IS20512C-XX-XX.

软管接头 HOSE FITTING

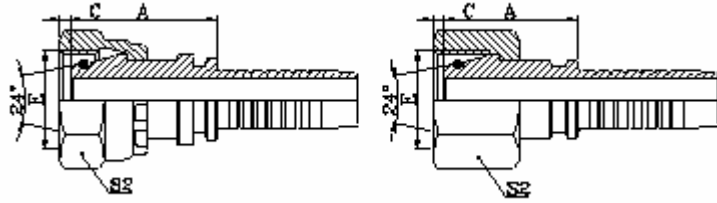

公制内螺纹
 锥带 O 形圈重系列
 ISO 12151-2—DIN 386
 METRIC FEMALE 24° CONE
 O-RING H.T.

20511

20511-T

| 代 号 | 螺 纹 E | 软 管 | | 管子外径 | O 形圈 | 尺 寸 | | |
|--------------|---------|------|-----|------|-----------|------|-----|----|
| | | 公称内径 | 标 号 | | | A | C | S1 |
| 20511-14-04 | M16X1.5 | 6 | 04 | 6 | O04.5X1.5 | 27.4 | 1.5 | 19 |
| 20511-16-04 | M16X1.5 | 6 | 04 | 8 | O06.5X1.5 | 27.5 | 1.5 | 22 |
| 20511-16-05 | M16X1.5 | 8 | 05 | 8 | O06.5X1.5 | 27.5 | 1.5 | 22 |
| 20511-18-04T | M18X1.5 | 6 | 04 | 10 | O08.0X1.5 | 26 | 1.5 | 22 |
| 20511-18-06 | M18X1.5 | 10 | 06 | 10 | O08.0X1.5 | 29.5 | 2 | 24 |
| 20511-20-06T | M20X1.5 | 10 | 06 | 12 | O10.0X1.5 | 27.5 | 2.5 | 24 |
| 20511-20-08 | M20X1.5 | 12 | 08 | 12 | O10.0X1.5 | 31.5 | 2.5 | 27 |
| 20511-22-06T | M22X1.5 | 10 | 06 | 14 | O11.0X2.0 | 28.5 | 3 | 27 |
| 20511-22-08 | M22X1.5 | 12 | 08 | 14 | O11.0X2.0 | 32.5 | 2.5 | 27 |
| 20511-24-06T | M24X1.5 | 10 | 06 | 16 | O13.0X2.0 | 27 | 3 | 30 |
| 20511-24-08T | M24X1.5 | 12 | 08 | 16 | O13.0X2.0 | 30 | 3 | 30 |
| 20511-30-10T | M30X2 | 16 | 10 | 20 | O16.3X2.4 | 33.5 | 2.5 | 36 |
| 20511-30-12 | M30X2 | 20 | 12 | 20 | O16.3X2.4 | 37 | 3 | 36 |
| 20511-36-12T | M36X2 | 20 | 12 | 25 | O20.3X2.4 | 37 | 3.2 | 46 |
| 20511-36-14T | M36X2 | 22 | 14 | 25 | O20.3X2.4 | 37 | 3.2 | 46 |
| 20511-42-12T | M42X2 | 20 | 12 | 30 | O25.3X2.4 | 37.5 | 3.9 | 50 |
| 20511-42-16T | M42X2 | 25 | 16 | 30 | O25.3X2.4 | 41 | 3.9 | 50 |
| 20511-52-20T | M52X2 | 32 | 20 | 38 | O33.3X2.4 | 44 | 4.5 | 60 |
| 20511-52-24T | M52X2 | 40 | 24 | 38 | O33.3X2.4 | 44 | 4.5 | 60 |

注: 1. 上述代号用于编织软管。 2. 如需用于缠绕软管代号改为 20512-xx-xx。

NOTE : 1. FOR USE WITH BRAIDED HOSES 2. IF USE WITH SPIRAL HOSES , HOSE FITTINGS SERIES NUMBER IS20512-XX-XX.

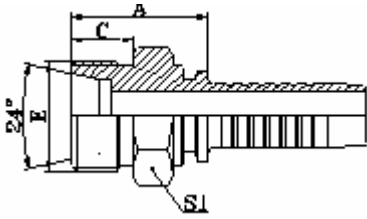

10511
公制外螺纹 24° 内锥面重系列
ISO-84341—DIN 3861
METRIC MALE 24° CONE SEAT H.T.

| 代 号 | 螺 纹 E | 软 管 | | 管子外径 | 尺 寸 | | | |
|-------------|---------|------|-----|------|------|----|----|--|
| | | 公称内径 | 标 号 | | A | C | S1 | |
| 10511-14-04 | M14X1.5 | 6 | 04 | 6 | 24 | 12 | 14 | |
| 10511-16-04 | M16X1.5 | 6 | 04 | 8 | 24.5 | 12 | 17 | |
| 10511-18-04 | M18X1.5 | 6 | 04 | 10 | 25 | 12 | 19 | |
| 10511-20-05 | M20X1.5 | 8 | 05 | 12 | 26 | 12 | 22 | |
| 10511-20-06 | M20X1.5 | 10 | 06 | 12 | 26 | 12 | 22 | |
| 10511-22-05 | M22X1.5 | 8 | 05 | 14 | 28.5 | 14 | 24 | |
| 10511-22-06 | M22X1.5 | 10 | 06 | 14 | 28.5 | 14 | 24 | |
| 10511-22-08 | M22X1.5 | 12 | 08 | 14 | 29 | 14 | 24 | |
| 10511-24-08 | M24X1.5 | 12 | 08 | 16 | 30 | 14 | 27 | |
| 10511-30-10 | M30X2 | 16 | 10 | 20 | 35.5 | 16 | 32 | |
| 10511-30-12 | M30X2 | 20 | 12 | 20 | 35.5 | 16 | 32 | |
| 10511-36-12 | M36X2 | 20 | 12 | 25 | 38.5 | 18 | 38 | |
| 10511-36-16 | M36X2 | 25 | 16 | 25 | 40 | 18 | 38 | |
| 10511-42-16 | M42X2 | 25 | 16 | 30 | 43 | 20 | 46 | |
| 10511-42-20 | M42X2 | 32 | 20 | 30 | 44 | 20 | 46 | |
| 10511-52-20 | M52X2 | 32 | 20 | 38 | 48 | 22 | 55 | |

注: 1.上述代号用于编织软管。 2. 如需用于缠绕软管代号改为 20512-xx-xx。

NOTE : 1. FOR USE WITH BRAIDED HOSES 2. IF USE WITH SPIRAL HOSES , HOSE FITTINGS SERIES NUMBER IS 10512-XX-XX.

20491C

20491C-T

90° 公制内螺纹 24° 球面轻系列
90°METRIC FEMALE 24° CONE
MULTISEAL L.T.

| 代 号 | 螺 纹 E | 软 管 | | 管子外径 | 尺 寸 | | | |
|---------------|---------|------|-----|------|-------|-----|-------|----|
| | | 公称内径 | 标 号 | | A | C | H | S2 |
| 20491C-14-04 | M14X1.5 | 6 | 04 | 8 | 30 | 3.5 | 39.5 | 19 |
| 20491C-16-04 | M16X1.5 | 6 | 04 | 10 | 30 | 3.5 | 40 | 22 |
| 20491C-16-05 | M16X1.5 | 8 | 05 | 10 | 33 | 3.5 | 43 | 22 |
| 20491C-16-06 | M16X1.5 | 10 | 06 | 10 | 35.25 | 3.5 | 45.2 | 22 |
| 20491C-18-06 | M18X1.5 | 10 | 06 | 12 | 35.25 | 3 | 47.25 | 24 |
| 20491C-22-08 | M22X1.5 | 12 | 08 | 15 | 41 | 4.5 | 53 | 27 |
| 20491C-26-10 | M26X1.5 | 16 | 10 | 18 | 56.5 | 4 | 60 | 32 |
| 20491C-30-12 | M30X2 | 20 | 12 | 22 | 65.5 | 7 | 38.5 | 36 |
| 20491C-36-12T | M36X2 | 20 | 12 | 28 | 65.5 | 6.5 | 67.5 | 41 |

注: 1.上述代号用于编织软管。 2. 如需用于缠绕软管代号改为 20491C-xx-xx。

NOTE : 1. FOR USE WITH BRAIDED HOSES 2. IF USE WITH SPIRAL HOSES , HOSE FITTINGS SERIES NUMBER IS 20492C-XX-XX.

软管接头 HOSE FITTING

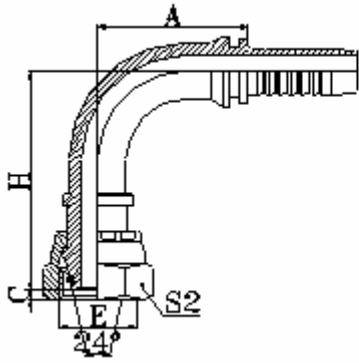

20491

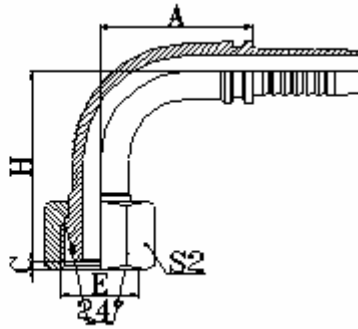

20491-T

90°公制内螺纹 24°锥带 O 形圈轻系列
 ISO 12151-2-DIN 3865
 90° METRIC FEMALE 24° CONE O-RING

| 代 号 | 螺纹 E | 软 管 | | 管子外径 | O 形圈 | 尺 寸 | | | |
|--------------|---------|------|-----|------|-----------|------|-----|-------|----|
| | | 公称内径 | 标 号 | | | A | C | H | S2 |
| 20491-12-03 | M12X1.5 | 5 | 03 | 6 | O04.5X1.5 | 25.6 | 1 | 34.5 | 17 |
| 20491-12-04 | M12X1.5 | 6 | 04 | 6 | O04.5X1.5 | 27.5 | 1 | 43 | 17 |
| 20491-14-04 | M14X1.5 | 6 | 04 | 8 | O06.5X1.5 | 27.5 | 2 | 44.5 | 19 |
| 20491-16-04 | M16X1.5 | 6 | 04 | 10 | O08.0X1.5 | 27.5 | 2 | 45 | 22 |
| 20491-16-05 | M16X1.5 | 8 | 05 | 10 | O08.0X1.5 | 31 | 2 | 49.5 | 22 |
| 20491-16-06 | M16X1.5 | 10 | 06 | 10 | O08.0X1.5 | 33 | 2 | 50.5 | 22 |
| 20491-18-05T | M18X1.5 | 8 | 05 | 12 | O10.0X1.5 | 31 | 1.5 | 43 | 22 |
| 20491-18-06 | M18X1.5 | 10 | 06 | 12 | O10.0X1.5 | 33 | 2.5 | 52.5 | 24 |
| 20491-22-06T | M22X1.5 | 10 | 06 | 15 | O12.0X2.0 | 33 | 3 | 47 | 27 |
| 20491-22-08 | M22X1.5 | 12 | 08 | 15 | O12.0X2.0 | 42.5 | 2.5 | 62.5 | 27 |
| 20491-26-08T | M26X1.5 | 12 | 08 | 18 | O15.0X2.0 | 42.5 | 2.1 | 54.5 | 32 |
| 20491-26-10 | M26X1.5 | 16 | 10 | 18 | O15.0X2.0 | 48.5 | 2.5 | 68 | 32 |
| 20491-26-12 | M26X1.5 | 20 | 12 | 18 | O15.0X2.0 | 50.5 | 2.5 | 76 | 32 |
| 20491-30-10T | M30X2 | 16 | 10 | 22 | O20.0X2.0 | 48.5 | 3.8 | 59.5 | 36 |
| 20491-30-12 | M30X2 | 20 | 12 | 22 | O20.0X2.0 | 50.5 | 4 | 78 | 36 |
| 20491-36-12T | M36X2 | 20 | 12 | 28 | O26.0X2.0 | 50.5 | 4.5 | 71 | 46 |
| 20491-36-14T | M36X2 | 22 | 14 | 28 | O26.0X2.0 | | 4.5 | | 46 |
| 20491-45-16T | M45X2 | 25 | 16 | 35 | O32.0X2.5 | 66 | 4 | 83 | 55 |
| 20491-45-20T | M45X2 | 32 | 20 | 35 | O32.0X2.5 | 75 | 4 | 95 | 55 |
| 20491-52-20T | M52X2 | 32 | 20 | 42 | O38.0X2.5 | 75 | 4 | 96.5 | 60 |
| 20491-52-24T | M52X2 | 40 | 24 | 42 | O38.0X2.5 | 89 | 4 | 108.5 | 60 |

注: 1. 上述代号用于编织软管。 2. 如需用于缠绕软管代号改为 204922-xx-xx。

NOTE : 1. FOR USE WITH BRAIDED HOSES 2. IF USE WITH SPIRAL HOSES , HOSE FITTINGS SERIES NUMBER IS 20492XX-XX.

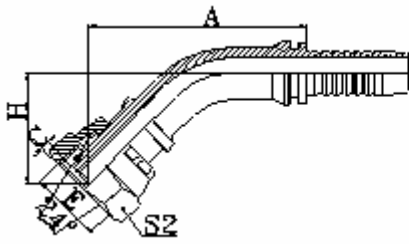

20441

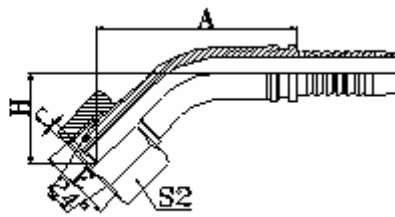

20441-T

45°公制内螺纹 24°锥带 O 形圈轻系列
ISO 12151-2-DIN 3865
45° METRIC FEMALE 24° CONE L.T.

| 代 号 | 螺纹 E | 软 管 | | 管子外径 | O 形圈 | 尺 寸 | | | |
|--------------|---------|------|-----|------|-----------|-------|-----|------|----|
| | | 公称内径 | 标 号 | | | A | C | H | S2 |
| 20441-12-04 | M14X1.5 | 6 | 04 | 8 | O06.5X1.5 | 45 | 2 | 26 | 19 |
| 20441-16-05 | M16X1.5 | 8 | 05 | 10 | O08.0X1.5 | 49.5 | 2 | 27.8 | 22 |
| 20441-16-06 | M16X1.5 | 10 | 06 | 10 | O08.0X1.5 | 51.3 | 2 | 27.8 | 22 |
| 20441-18-05T | M18X1.5 | 8 | 05 | 12 | O10.0X1.5 | 44.7 | 1.5 | 23.2 | 22 |
| 20441-18-06 | M18X1.5 | 10 | 06 | 12 | O10.0X1.5 | 53 | 2.5 | 29 | 24 |
| 20441-22-05T | M22X1.5 | 8 | 05 | 15 | O12.0X2 | | 3 | | 27 |
| 20441-22-06T | M22X1.5 | 10 | 06 | 15 | O12.0X2 | 49 | 3 | 25.3 | 27 |
| 20441-22-08 | M22X1.5 | 12 | 08 | 15 | O12.0X2 | 66.5 | 2.5 | 34 | 27 |
| 20441-26-08T | M26X1.5 | 12 | 08 | 18 | O15.0X2 | 61 | 2.1 | 28 | 32 |
| 20441-26-10 | M26X1.5 | 16 | 10 | 18 | O15.0X2 | 70 | 2.5 | 36 | 32 |
| 20441-26-12 | M26X1.5 | 20 | 12 | 18 | O15.0X2 | | 2.5 | | 32 |
| 20441-30-10T | M30X1.5 | 16 | 10 | 22 | O20.0X2 | 64 | 3.8 | 30 | 36 |
| 20441-30-12 | M30X1.5 | 20 | 12 | 22 | O20.0X2 | 84.5 | 4 | 40.5 | 36 |
| 20441-36-12T | M36X1.5 | 20 | 12 | 28 | O28.0X2 | 79.3 | 4.5 | 35.5 | 46 |
| 20441-36-14T | M36X2 | 22 | 14 | 28 | O28.0X2 | | 4.5 | | 46 |
| 20441-45-20T | M45X2 | 32 | 20 | 35 | O35.0X2 | 101.8 | 4 | 42.4 | 55 |
| 20441-52-20T | M52X2 | 32 | 20 | 42 | O42.0X2 | | 4 | 46.6 | 60 |
| 20441-52-24T | M52X2 | 40 | 24 | 42 | O42.0X2 | 113 | 4 | | 60 |

注: 1.上述代号用于编织软管。 2. 如需用于缠绕软管代号改为 20412-xx-xx。

NOTE : 1. FOR USE WITH BRAIDED HOSES 2. IF USE WITH SPIRAL HOSES , HOSE FITTINGS SERIES NUMBER IS 20412-XX-XX.

20411C 20411C-T

公制内螺纹 24°球面 轻系列
METRIC FEMALE MULTISEAL 24° CONE L.T.

| 代 号 | 螺 纹 E | 软 管 | | 管子外径 | 尺 寸 | | |
|---------------|---------|------|-----|------|------|-----|----|
| | | 公称内径 | 标 号 | | A | C | S2 |
| 20411C-12-04 | M12X1.5 | 6 | 04 | 6 | 19.5 | 3.5 | 17 |
| 20411C-14-04 | M14X1.5 | 6 | 04 | 8 | 20.5 | 3.5 | 19 |
| 20411C-16-04 | M16X1.5 | 6 | 04 | 10 | 21 | 3.5 | 22 |
| 20411C-16-05 | M16X1.5 | 8 | 05 | 10 | 21 | 3.5 | 22 |
| 20411C-16-06 | M16X1.5 | 10 | 06 | 10 | 21 | 3.5 | 22 |
| 20411C-18-06 | M18X1.5 | 10 | 06 | 12 | 22.5 | 3 | 24 |
| 20411C-22-06T | M22X1.5 | 10 | 06 | 15 | 23.5 | 4.5 | 27 |
| 20411C-22-08 | M22X1.5 | 12 | 08 | 15 | 24 | 4.5 | 27 |
| 20411C-26-10 | M26X1.5 | 16 | 10 | 18 | 27 | 4 | 32 |
| 20411C-30-10T | M30X2 | 16 | 10 | 22 | 26.5 | 7 | 36 |
| 20411C-30-12 | M30X2 | 20 | 12 | 22 | 27 | 7 | 36 |
| 20411C-30-14 | M30X2 | 22 | 14 | 22 | 27 | 7 | 36 |
| 20411C-36-16 | M36X2 | 25 | 16 | 28 | 29 | 6.5 | 41 |
| 20411C-45-20T | M45X2 | 32 | 20 | 35 | 33 | 7 | 55 |
| 20411C-52-24T | M52X2 | 40 | 24 | 42 | 34 | 8 | 60 |

注: 1.上述代号用于编织软管。 2. 如需用于缠绕软管代号改为 20412C-xx-xx。

NOTE : 1. FOR USE WITH BRAIDED HOSES 2. IF USE WITH SPIRAL HOSES , HOSE FITTINGS SERIES NUMBER IS 20412C-XX-XX.

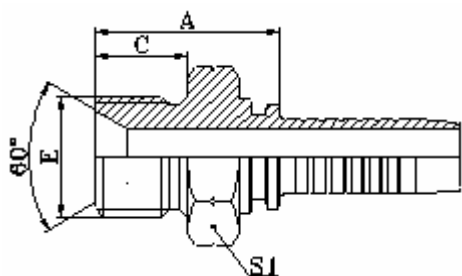

12611A

英管外螺纹 60° 内锥面或六角端面

用组合垫密封的双用接头

BSP MALE DOUBLE USE FOR 60° CONE SEAT
OR BONDED SEAL

| 代 号 | 管子外径 D | 软 管 | | 尺 寸 | | | |
|--------------|------------|------|-----|------|------|----|--|
| | | 公称内径 | 标 号 | A | C | S1 | |
| 12611A-02-03 | G1/8"X28 | 5 | 03 | 22 | 10 | 14 | |
| 12611A-04-04 | G1/4"X19 | 6 | 04 | 25 | 12 | 19 | |
| 12611A-04-05 | G3/8"X19 | 8 | 05 | 25 | 12 | 19 | |
| 12611A-06-05 | G3/8"X19 | 8 | 05 | 26 | 13.5 | 22 | |
| 12611A-06-06 | G3/8"X19 | 10 | 06 | 27.5 | 13.5 | 22 | |
| 12611A-06-08 | G3/8"X19 | 12 | 08 | 28.5 | 13.5 | 22 | |
| 12611A-08-06 | G1/2"X14 | 10 | 06 | 33 | 16 | 27 | |
| 12611A-08-08 | G1/2"X14 | 12 | 08 | 32 | 16 | 27 | |
| 12611A-08-10 | G1/2"X14 | 16 | 10 | 32 | 16 | 27 | |
| 12611A-10-08 | G5/8"X14 | 12 | 08 | 35 | 17.5 | 30 | |
| 12611A-10-10 | G5/8"X14 | 16 | 10 | 36 | 17.5 | 30 | |
| 12611A-12-08 | G3/4"X14 | 12 | 08 | 36.5 | 18.5 | 32 | |
| 12611A-12-10 | G3/4"X14 | 16 | 10 | 37.5 | 18.5 | 32 | |
| 12611A-12-12 | G3/4"X14 | 20 | 12 | 38 | 18.5 | 32 | |
| 12611A-16-12 | G1"X11 | 20 | 12 | 42.5 | 20.5 | 41 | |
| 12611A-16-16 | G1"X11 | 25 | 16 | 43 | 20.5 | 41 | |
| 12611A-20-16 | G1.1/4"X11 | 25 | 16 | 45.5 | 20.5 | 50 | |
| 12611A-20-20 | G1.1/4"X11 | 32 | 20 | 45.5 | 20.5 | 50 | |
| 12611A-24-24 | G1.1/2"X11 | 40 | 24 | 50 | 23 | 55 | |
| 12611A-32-32 | G2"X11 | 50 | 32 | 54.5 | 25.5 | 70 | |

注: 1. 上述代号用于编织软管。 2. 如需用于缠绕软管代号改为 12612A-xx-xx。

NOTE : 1. FOR USE WITH BRAIDED HOSES 2. IF USE WITH SPIRAL HOSES , HOSE FITTINGS
SERIES NUMBER IS 12612A-XX-XX.

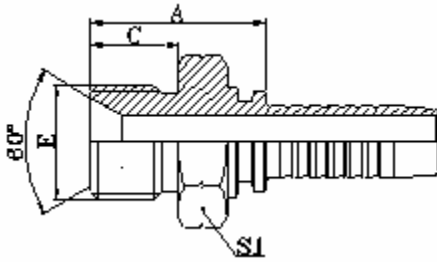

12611

BSP MALE 60° CONE SEAT

英管外螺纹 60° 内锥面

| 代 号 | 管子外径 D | 软 管 | | 尺 寸 | | | |
|-------------|------------|------|-----|------|------|----|--|
| | | 公称内径 | 标 号 | A | C | S1 | |
| 12611-02-03 | G1/8"X28 | 5 | 03 | 22 | 10 | 12 | |
| 12611-04-04 | G1/4"X19 | 6 | 04 | 24 | 12 | 14 | |
| 12611-06-05 | G3/8"X19 | 8 | 05 | 26 | 13.5 | 17 | |
| 12611-06-06 | G3/8"X19 | 10 | 06 | 26 | 13.5 | 17 | |
| 12611-06-08 | G3/8"X19 | 12 | 08 | 26.5 | 13.5 | 19 | |
| 12611-08-06 | G1/2"X14 | 10 | 06 | 30.5 | 16 | 22 | |
| 12611-08-08 | G1/2"X14 | 12 | 08 | 30.5 | 16 | 22 | |
| 12611-10-08 | G5/8"X14 | 12 | 08 | 32.5 | 17.5 | 24 | |
| 12611-10-10 | G5/8"X14 | 16 | 10 | 34 | 17.5 | 24 | |
| 12611-12-08 | G3/4"X14 | 12 | 08 | 35.5 | 18.5 | 27 | |
| 12611-12-10 | G3/4"X14 | 16 | 10 | 37 | 18.5 | 27 | |
| 12611-12-12 | G3/4"X14 | 20 | 12 | 36 | 18.5 | 27 | |
| 12611-16-12 | G1"X11 | 20 | 12 | 40.5 | 20.5 | 36 | |
| 12611-16-16 | G1"X11 | 25 | 16 | 42.5 | 20.5 | 36 | |
| 12611-20-16 | G1.1/4"X11 | 25 | 16 | 43.5 | 20.5 | 46 | |
| 12611-20-20 | G1.1/4"X11 | 32 | 20 | 44.5 | 20.5 | 46 | |
| 12611-24-20 | G1.1/2"X11 | 32 | 20 | 49 | 23 | 50 | |
| 12611-24-24 | G1.1/2"X11 | 40 | 24 | 49 | 23 | 50 | |
| 12611-32-32 | G2"X11 | 50 | 32 | 54.5 | 25.5 | 65 | |

注: 1.上述代号用于编织软管。 2. 如需用于缠绕软管代号改为 12612-xx-xx。

NOTE : 1. FOR USE WITH BRAIDED HOSES 2. IF USE WITH SPIRAL HOSES , HOSE FITTINGS SERIES NUMBER IS12612-XX-XX.

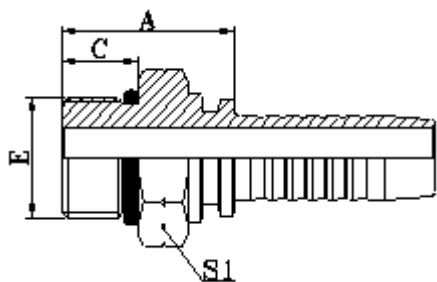

12211

BSP MALE O-RING SEAL

英管外螺纹 O 形圈密封

| 代 号 | 管子外径 D | 软 管 | | O 形圈 | 尺 寸 | | |
|-------------|------------|------|-----|------|------|------|----|
| | | 公称内径 | 标 号 | | A | C | H |
| 12211-04-04 | G1/4"X19 | 6 | 04 | | 24 | 11 | 19 |
| 12211-04-06 | G1/4"X19 | 10 | 06 | | 23.5 | 11 | 19 |
| 12211-06-06 | G3/8"X19 | 10 | 06 | | 26 | 12 | 22 |
| 12211-08-04 | G1/2"X14 | 6 | 04 | | 33.5 | 14 | 27 |
| 12211-08-06 | G1/2"X14 | 10 | 06 | | 33.5 | 14 | 27 |
| 12211-08-08 | G1/2"X14 | 12 | 08 | | 30 | 14 | 27 |
| 12211-10-10 | G5/8"X14 | 16 | 10 | | 34 | 15.5 | 30 |
| 12211-12-10 | G3/4"X14 | 16 | 10 | | 35 | 15.5 | 32 |
| 12211-12-12 | G3/4"X14 | 20 | 12 | | 35 | 15.5 | 32 |
| 12211-12-16 | G3/4"X14 | 25 | 16 | | 36 | 15.5 | 32 |
| 12211-16-16 | G1"X11 | 25 | 16 | | 41 | 18.5 | 41 |
| 12211-20-20 | G1.1/4"X11 | 32 | 20 | | 45 | 20 | 50 |

注: 1. 上述代号用于编织软管。 2. 如需用于缠绕软管代号改为 12212-xx-xx。

NOTE : 1. FOR USE WITH BRAIDED HOSES 2. IF USE WITH SPIRAL HOSES , HOSE FITTINGS SERIES NUMBER IS 12212-XX-XX.

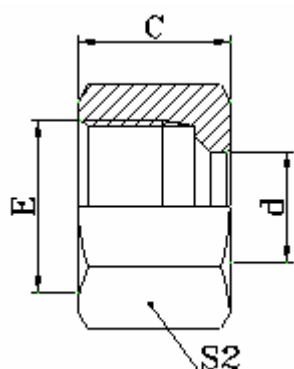

NL
NS
RETAINING NUT L.T.

卡套螺母

| 代 号 | 螺纹 E | 管子外径 | | 尺 寸 | | | 压力等级 MPa |
|--------|---------|------|--|------|----|----|-------------|
| | | | | C | D | S2 | |
| NL-12 | M12X1.5 | 6 | | 14.5 | 6 | 14 | 轻系列 L |
| NL-14 | M14X1.5 | 8 | | 14.5 | 8 | 17 | |
| NL-16 | M16X1.5 | 10 | | 15.5 | 10 | 19 | |
| NL-18 | M18X1.5 | 12 | | 15.5 | 12 | 22 | |
| NL-22 | M22X1.5 | 15 | | 17 | 15 | 27 | |
| NL-26 | M26X1.5 | 18 | | 18 | 18 | 32 | |
| NL-30 | M30X2 | 22 | | 20 | 22 | 36 | |
| NL-30D | M30X1.5 | 22 | | 19 | 22 | 36 | |
| NL-36 | M36X2 | 28 | | 21 | 28 | 41 | |
| NL-36D | M36X1.5 | 28 | | 21 | 28 | 41 | |
| NL-45 | M45X2 | 35 | | 24 | 35 | 50 | |
| NL-45D | M45X1.5 | 35 | | 25 | 35 | 50 | |
| NL-52 | M52X2 | 42 | | 24 | 42 | 60 | |
| NS-14 | M14X1.5 | 6 | | 16.5 | 6 | 17 | |
| NS-16 | M16X1.5 | 8 | | 16.5 | 8 | 19 | |
| NS-18 | M18X1.5 | 10 | | 17.5 | 10 | 22 | |
| NS-20 | M20X1.5 | 12 | | 17.5 | 12 | 24 | |
| NS-22 | M22X1.5 | 14 | | 20.5 | 14 | 27 | |
| NS-24 | M24X1.5 | 16 | | 20.5 | 16 | 30 | |
| NS-30 | M30X2 | 20 | | 24 | 20 | 36 | |
| NS-36 | M36X2 | 25 | | 27 | 25 | 46 | |
| NS-42 | M42X2 | 30 | | 29 | 30 | 50 | |
| NS-52 | M52X2 | 38 | | 32.5 | 38 | 60 | |

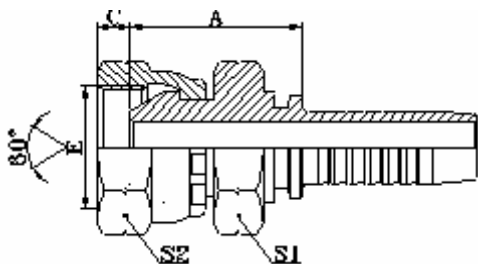

22611D

英管内螺纹 60° 外锥面双六角

BSP FEMALE 60°CONE DOUBLE HEXAGON

| 代 号 | 管子外径 D | 软 管 | | 尺 寸 | | | |
|---------------|------------|------|-----|------|------|----|----|
| | | 公称内径 | 标 号 | A | C | S1 | S2 |
| 22611D-04-04 | G1/4"X19 | 6 | 04 | 24.5 | 5.5 | 19 | 19 |
| 22611D-06-06 | G3/8"X19 | 10 | 06 | 27 | 6.3 | 22 | 22 |
| 22611D-08-08 | G1/2"X14 | 12 | 08 | 30.5 | 7.5 | 27 | 27 |
| 22611D-10-08 | G5/8"X14 | 12 | 08 | 31 | 9.5 | 30 | 30 |
| 22611D-12-08 | G3/4"X14 | 12 | 08 | 31.5 | 10.9 | 32 | 32 |
| 22611D-12-12 | G3/4"X14 | 20 | 12 | 34.5 | 10.9 | 32 | 32 |
| 22611D-16-16 | G1"X11 | 25 | 16 | 38.5 | 11.7 | 41 | 41 |
| 22611D-20-20W | G1.1/4"X11 | 32 | 20 | 44 | 11 | 50 | 50 |

注: 1.上述代号用于编织软管。 2. 如需用于缠绕软管代号改为 22612D-xx-xx。

NOTE : 1. FOR USE WITH BRAIDED HOSES 2. IF USE WITH SPIRAL HOSES , HOSE FITTINGS SERIES NUMBER IS 22612D-XX-XX.

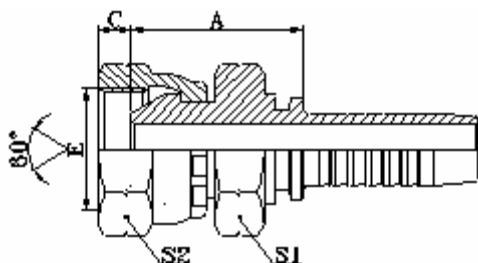

22611D-SM

英管内螺纹 60° 外锥面双六角

BSP FEMALE 60°CONE DOUBLE HEXAGON

| 代 号 | 管子外径 D | 软 管 | | 尺 寸 | | | |
|----------------|------------|------|-----|------|------|----|----|
| | | 公称内径 | 标 号 | A | C | S1 | S2 |
| 22611D-04-04SM | G1/4"X19 | 6 | 04 | 23.5 | 5.5 | 12 | 19 |
| 22611D-06-06SM | G3/8"X19 | 10 | 06 | 24.5 | 6.3 | 17 | 22 |
| 22611D-08-08SM | G1/2"X14 | 12 | 08 | 29 | 7.5 | 22 | 27 |
| 22611D-10-08SM | G5/8"X14 | 12 | 08 | 29 | 9.5 | 22 | 30 |
| 22611D-12-08SM | G3/4"X14 | 12 | 08 | 31.5 | 10.9 | 27 | 32 |
| 22611D-12-12SM | G3/4"X14 | 20 | 12 | 33.5 | 10.9 | 27 | 32 |
| 22611D-16-16SM | G1"X11 | 25 | 16 | 35.5 | 11.7 | 32 | 41 |
| 22611D-20-20SM | G1.1/4"X11 | 32 | 20 | 42 | 11 | 41 | 50 |

注: 1.上述代号用于编织软管。 2. 如需用于缠绕软管代号改为 22612D-xx-xxSM。

NOTE : 1. FOR USE WITH BRAIDED HOSES 2. IF USE WITH SPIRAL HOSES , HOSE FITTINGS SERIES NUMBER IS 22612D-XX-XXSM.

软管接头 HOSE FITTING

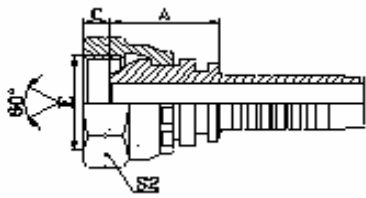

22611

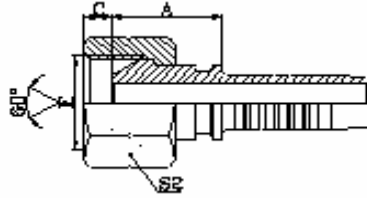

22611-T

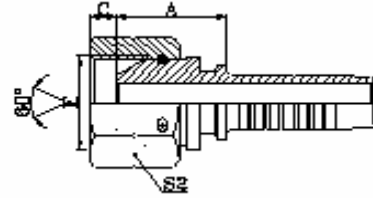

22611-W

英管内螺纹 60° 外锥面

BSP FEMALE 60° CONE

| 代 号 | 管子外径 D | 软 管 | | 尺 寸 | | | |
|--------------|------------|------|-----|------|------|----|--|
| | | 公称内径 | 标 号 | A | C | S2 | |
| 22611-02-03 | G1/8"X28 | 5 | 03 | 15 | 5.5 | 14 | |
| 22611-02-04 | G1/8"X28 | 6 | 04 | 17.5 | 5.5 | 14 | |
| 22611-04-03 | G1/4"X19 | 5 | 03 | 17 | 5.5 | 19 | |
| 22611-04-04 | G1/4"X19 | 6 | 04 | 19 | 5.5 | 19 | |
| 22611-04-05 | G1/4"X19 | 8 | 05 | 19 | 5.5 | 19 | |
| 22611-04-06 | G1/4"X19 | 10 | 06 | 19 | 5.5 | 19 | |
| 22611-06-04 | G3/8"X19 | 6 | 04 | 21 | 6.3 | 22 | |
| 22611-06-05 | G3/8"X19 | 8 | 05 | 21 | 6.3 | 22 | |
| 22611-06-06 | G3/8"X19 | 10 | 06 | 21 | 6.3 | 22 | |
| 22611-06-08 | G3/8"X19 | 12 | 08 | 21.5 | 6.3 | 22 | |
| 22611-08-06T | G1/2"X14 | 10 | 06 | 21 | 7.5 | 27 | |
| 22611-08-08 | G1/2"X14 | 12 | 08 | 23 | 7.5 | 27 | |
| 22611-10-08 | G5/8"X14 | 12 | 08 | 23.5 | 9.5 | 30 | |
| 22611-10-10 | G5/8"X14 | 16 | 10 | 24.5 | 9.5 | 30 | |
| 22611-12-08T | G3/4"X14 | 12 | 08 | 22 | 10.9 | 32 | |
| 22611-12-10 | G3/4"X14 | 16 | 10 | 24.5 | 10.9 | 32 | |
| 22611-12-12 | G3/4"X14 | 20 | 12 | 24.5 | 10.9 | 32 | |
| 22611-16-12T | G1"X11 | 20 | 12 | 24 | 11.7 | 41 | |
| 22611-16-14 | G1"X11 | 22 | 14 | 26 | 11.7 | 41 | |
| 22611-16-16 | G1"X11 | 25 | 16 | 27.5 | 11.7 | 41 | |
| 22611-20-16T | G1.1/4"X11 | 25 | 16 | 27.5 | 11 | 50 | |
| 22611-20-20W | G1.1/4"X11 | 32 | 20 | 30.5 | 11 | 50 | |
| 22611-24-20T | G1.1/2"X11 | 32 | 20 | 32 | 13 | 55 | |
| 22611-24-24W | G1.1/2"X11 | 40 | 24 | 32 | 13 | 55 | |
| 22611-32-24T | G2"X11 | 40 | 24 | 30 | 16 | 70 | |
| 22611-32-32W | G2"X11 | 50 | 32 | 31.9 | 16 | 70 | |

注: 1. 上述代号用于编织软管。 2. 如需用于缠绕软管代号改为 22612-xx-xx。

NOTE : 1. FOR USE WITH BRAIDED HOSES 2. IF USE WITH SPIRAL HOSES , HOSE FITTINGS SERIES NUMBER IS 22612-XX-XX.

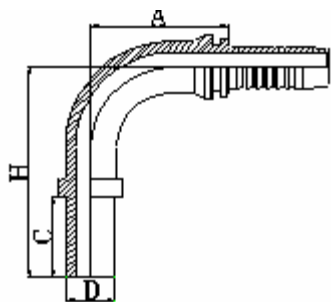

51091

90° 国际卡套式直管

90°BSP STANDARD PIPE

| 代 号 | 管子外径 D | 软 管 | | 尺 寸 | | | |
|-------------|--------|------|-----|-----|-------|----|------|
| | | 公称内径 | 标 号 | | A | C | H |
| 51091-06-04 | 6 | 6 | 04 | | 30.5 | 19 | 42.5 |
| 51091-06-06 | 6 | 10 | 06 | | 35.3 | 19 | 47.8 |
| 51091-08-04 | 8 | 6 | 04 | | 30 | 19 | 42.5 |
| 51091-08-05 | 8 | 8 | 05 | | 33 | 19 | 45.5 |
| 51091-10-04 | 10 | 6 | 04 | | 30 | 22 | 45.5 |
| 51091-10-06 | 10 | 10 | 06 | | 35.8 | 22 | 50.8 |
| 51091-12-06 | 12 | 10 | 06 | | 35.3 | 22 | 50.8 |
| 51091-12-08 | 12 | 12 | 08 | | 41 | 22 | 56 |
| 51091-14-06 | 14 | 10 | 06 | | 35.3 | 22 | 50.8 |
| 51091-14-08 | 14 | 12 | 08 | | 41 | 22 | 56 |
| 51091-15-10 | 15 | 16 | 10 | | 56.5 | 26 | 64.5 |
| 51091-16-08 | 16 | 12 | 08 | | 42 | 22 | 56 |
| 51091-16-10 | 16 | 16 | 10 | | 56.5 | 22 | 60.5 |
| 51091-18-10 | 18 | 16 | 10 | | 56.5 | 24 | 62.5 |
| 51091-18-12 | 18 | 20 | 12 | | 64.9 | 24 | 72 |
| 51091-22-14 | 22 | 22 | 14 | | 71.2 | 28 | 77 |
| 51091-28-16 | 28 | 25 | 16 | | 76.7 | 30 | 83.5 |
| 51091-34-20 | 34 | 32 | 20 | | 91.5 | 33 | 97.5 |
| 51091-42-24 | 42 | 40 | 24 | | 109.4 | 35 | 113 |

注: 1.上述代号用于编织软管。 2. 如需用于缠绕软管代号改为 51092-xx-xx。

NOTE : 1. FOR USE WITH BRAIDED HOSES 2. IF USE WITH SPIRAL HOSES , HOSE FITTINGS SERIES NUMBER IS 51092-XX-XX.

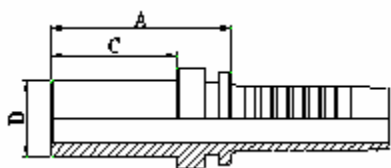

51011

国际卡套式直管

BSP STANDARD PIPE

| 代 号 | 管子外径 D | 软 管 | | 尺 寸 | | | |
|-------------|--------|------|-----|-----|------|----|--|
| | | 公称内径 | 标 号 | | A | C | |
| 51011-04-03 | 4 | 5 | | | 27 | 17 | |
| 51011-06-03 | 6 | 5 | | | 30.5 | 19 | |
| 51011-06-04 | 6 | 6 | | | 31 | 19 | |
| 51011-08-04 | 8 | 6 | | | 31 | 19 | |
| 51011-08-05 | 8 | 8 | | | 31.5 | 19 | |
| 51011-08-06 | 8 | 10 | | | 32 | 19 | |
| 51011-10-04 | 10 | 6 | | | 35 | 22 | |
| 51011-10-05 | 10 | 8 | | | 35 | 22 | |
| 51011-10-06 | 10 | 10 | | | 35 | 22 | |
| 51011-12-05 | 12 | 8 | | | 35 | 22 | |
| 51011-12-06 | 12 | 10 | | | 35 | 22 | |
| 51011-14-06 | 14 | 10 | | | 35 | 22 | |
| 51011-14-08 | 14 | 12 | | | 35.5 | 22 | |
| 51011-16-06 | 16 | 10 | | | 35 | 22 | |
| 51011-16-08 | 16 | 12 | | | 36 | 22 | |
| 51011-16-10 | 16 | 16 | | | 36.5 | 22 | |
| 51011-16-12 | 16 | 20 | | | 38 | 22 | |
| 51011-18-12 | 18 | 20 | | | 41.5 | 24 | |
| 51011-22-12 | 22 | 20 | | | 45 | 28 | |
| 51011-22-14 | 22 | 22 | | | 45 | 28 | |
| 51011-28-16 | 28 | 25 | | | 49 | 30 | |
| 51011-34-20 | 34 | 32 | | | 53 | 33 | |
| 51011-42-24 | 42 | 40 | | | 57 | 35 | |

注: 1.上述代号用于编织软管。 2. 如需用于缠绕软管代号改为 51012-xx-xx。

NOTE : 1. FOR USE WITH BRAIDED HOSES 2. IF USE WITH SPIRAL HOSES , HOSE FITTINGS SERIES NUMBER IS51012-XX-XX.

软管接头 HOSE FITTING

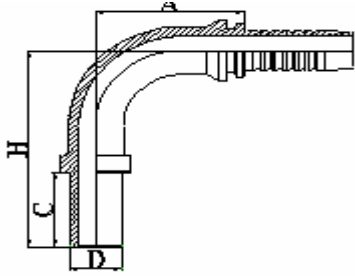

50091 90° 公制卡套式直管 90° METRIC STANDPIPE STRAIGHT DIN2353

| 代 号 | 管子外径 D | 软 管 | | 尺 寸 | | | 备 注 |
|-------------|--------|------|-----|-------|----|-------|-----|
| | | 公称内径 | 标 号 | A | C | H | |
| 50091-06-03 | 6 | 5 | 03 | 26.5 | 22 | 42.5 | 轻系列 |
| 50091-06-04 | 6 | 6 | 04 | 30 | 22 | 45.5 | |
| 50091-08-05 | 8 | 8 | 05 | 33 | 24 | 50.5 | |
| 50091-08-06 | 8 | 10 | 06 | 35.3 | 24 | 52.8 | |
| 50091-10-05 | 10 | 8 | 05 | 33 | 23 | 49.5 | |
| 50091-10-06 | 10 | 10 | 06 | 35.3 | 23 | 51.8 | |
| 50091-12-06 | 12 | 10 | 06 | 35.36 | 23 | 53.8 | |
| 50091-12-08 | 12 | 12 | 08 | 41 | 23 | 59 | |
| 50091-15-06 | 15 | 10 | 06 | 35.3 | 25 | 53.8 | |
| 50091-15-08 | 15 | 12 | 08 | 41 | 25 | 59 | |
| 50091-18-08 | 18 | 12 | 08 | 41 | 26 | 60 | |
| 50091-18-10 | 18 | 16 | 10 | 56.5 | 26 | 64.5 | |
| 50091-22-10 | 22 | 16 | 10 | 56.5 | 28 | 66.5 | |
| 50091-22-12 | 22 | 20 | 12 | 65.5 | 28 | 76 | |
| 50091-22-16 | 22 | 25 | 16 | 76.7 | 28 | 81.5 | |
| 50091-28-16 | 28 | 25 | 16 | 76.7 | 30 | 83.5 | |
| 50091-35-20 | 35 | 32 | 20 | 93 | 36 | 100.5 | |
| 50091-08-04 | 8 | 6 | 04 | 30 | 24 | 47.5 | 重系列 |
| 50091-10-04 | 10 | 6 | 04 | 30 | 26 | 49.5 | |
| 50091-12-04 | 12 | 6 | 04 | 30 | 26 | 49.5 | |
| 50091-12-05 | 12 | 8 | 05 | 33 | 26 | 52.5 | |
| 50091-14-06 | 14 | 10 | 06 | 35.3 | 29 | 57.8 | |
| 50091-14-08 | 14 | 12 | 08 | 41 | 29 | 63 | |
| 50091-16-08 | 16 | 12 | 08 | 41 | 30 | 64 | |
| 50091-16-10 | 16 | 16 | 10 | 56.5 | 30 | 68.5 | |
| 50091-20-10 | 20 | 16 | 10 | 56.5 | 36 | 74.5 | |
| 50091-20-12 | 20 | 20 | 12 | 65.5 | 36 | 85 | |
| 50091-25-12 | 25 | 20 | 12 | 65.5 | 40 | 89 | |
| 50091-25-16 | 25 | 25 | 16 | 76.7 | 40 | 93.5 | |
| 50091-30-16 | 30 | 25 | 16 | 76.7 | 40 | 93.5 | |
| 50091-30-20 | 30 | 32 | 20 | 91.5 | 44 | 108.5 | |
| 50091-38-16 | 38 | 25 | 16 | 76.7 | 50 | 115.5 | |
| 50091-38-20 | 38 | 32 | 20 | 91.5 | 50 | 114.5 | |

注: 1.上述代号用于编织软管。 2. 如需用于缠绕软管代号改为 50092-xx-xx。

NOTE : 1. FOR USE WITH BRAIDED HOSES 2. IF USE WITH SPIRAL HOSES , HOSE FITTINGS SERIES NUMBER IS50092-XX-XX.

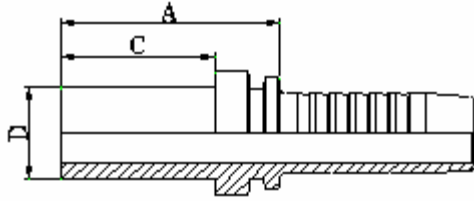

50011
公制卡套式直管
DIN2353
METRIC STANDPIPE STRAIGHT

| 代 号 | 管子外径 D | 软 管 | | 尺 寸 | | | 备 注 |
|-------------|--------|------|-----|------|----|--|-----|
| | | 公称内径 | 标 号 | A | C | | |
| 50011-06-03 | 6 | 5 | 03 | 28.5 | 22 | | 轻系列 |
| 50011-06-04 | 6 | 6 | 04 | 29 | 22 | | |
| 50011-10-05 | 10 | 8 | 05 | 31 | 23 | | |
| 50011-10-06 | 10 | 10 | 06 | 32 | 23 | | |
| 50011-12-06 | 12 | 10 | 06 | 32.5 | 23 | | |
| 50011-12-08 | 12 | 12 | 08 | 33 | 23 | | |
| 50011-15-06 | 15 | 10 | 06 | 35.5 | 25 | | |
| 50011-15-08 | 15 | 12 | 08 | 35.5 | 25 | | |
| 50011-18-08 | 18 | 12 | 08 | 36.5 | 26 | | |
| 50011-18-10 | 18 | 16 | 10 | 41 | 26 | | |
| 50011-22-10 | 22 | 16 | 10 | 44 | 28 | | |
| 50011-22-12 | 22 | 20 | 12 | 44 | 28 | | |
| 50011-22-16 | 22 | 25 | 16 | 46 | 28 | | |
| 50011-28-16 | 28 | 25 | 16 | 47 | 30 | | |
| 50011-35-20 | 35 | 32 | 20 | 56 | 36 | | |
| 50011-42-24 | 42 | 40 | 24 | 62 | 40 | | |
| 50011-08-04 | 8 | 6 | 04 | 31 | 24 | | 重系列 |
| 50011-08-05 | 8 | 8 | 05 | 33 | 24 | | |
| 50011-08-06 | 8 | 10 | 06 | 33 | 24 | | |
| 50011-10-04 | 10 | 6 | 04 | 33 | 26 | | |
| 50011-12-04 | 12 | 6 | 04 | 34.5 | 26 | | |
| 50011-12-05 | 12 | 8 | 05 | 35.5 | 26 | | |
| 50011-14-06 | 14 | 10 | 06 | 39.5 | 29 | | |
| 50011-14-08 | 14 | 12 | 08 | 40 | 29 | | |
| 50011-14-12 | 14 | 20 | 12 | 45.5 | 29 | | |
| 50011-16-08 | 16 | 12 | 08 | 40.5 | 30 | | |
| 50011-16-10 | 16 | 16 | 10 | 45.5 | 30 | | |
| 50011-20-10 | 20 | 16 | 10 | 52 | 36 | | |
| 50011-20-12 | 20 | 20 | 12 | 52.5 | 36 | | |
| 50011-25-12 | 25 | 20 | 12 | 56 | 40 | | |
| 50011-25-16 | 25 | 25 | 16 | 57 | 40 | | |
| 50011-30-16 | 30 | 25 | 16 | 63 | 44 | | |
| 50011-30-20 | 30 | 32 | 20 | 64 | 44 | | |
| 50011-38-16 | 38 | 25 | 16 | 69 | 50 | | |
| 50011-38-20 | 38 | 32 | 20 | 70 | 50 | | |

注: 1. 上述代号用于编织软管。 2. 如需用于缠绕软管代号改为 50012-xx-xx。

NOTE : 1. FOR USE WITH BRAIDED HOSES 2. IF USE WITH SPIRAL HOSES , HOSE FITTINGS SERIES NUMBER IS 50012-XX-XX.

软管接头 HOSE FITTING

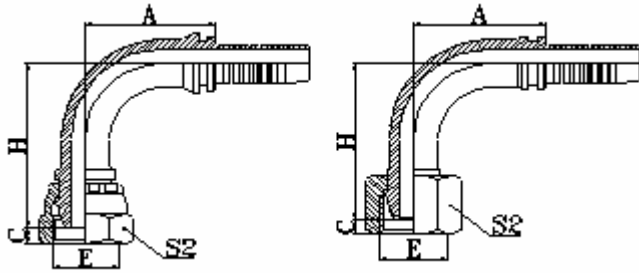

90° 公制内螺纹球面
90° METRIC FEMALE MULTISEAL

20191

20191-T

| 代 号 | 螺纹 E | 软 管 | | 尺 寸 | | | |
|---------------|---------|------------|-----|--------|-----|-------|-----|
| | | 公 称 内 径 | 标 号 | A | C | H | S2 |
| 20191-10-03 | M10X1 | 5 | 03 | 27 | 2.5 | 35.5 | 14 |
| 20191-12-04 | M12X1.5 | 6 | 04 | 30 | 4 | 37.5 | 17 |
| 20191-14-04 | M14X1.5 | 6 | 04 | 27.5 | 4.5 | 38 | 19 |
| 20191-14-05 | M14X1.5 | 8 | 05 | 33 | 4.5 | 41 | 19 |
| 20191-16-04 | M16X1.5 | 6 | 04 | 27.5 | 4.5 | 38.5 | 19 |
| 20191-16-05 | M16X1.5 | 8 | 05 | 31 | 4.5 | 43 | 22 |
| 20191-16-06 | M16X1.5 | 10 | 06 | 35.3 | 4.5 | 43.8 | 22 |
| 20191-18-05T | M18X1.5 | 8 | 05 | 31 | 4 | 43 | 24 |
| 20191-18-06 | M18X1.5 | 10 | 06 | 35.3 | 4 | 45.3 | 24 |
| 20191-18-08 | M18X1.5 | 12 | 08 | 40.5 | 4 | 50.5 | 24 |
| 20191-20-06T | M20X1.5 | 10 | 06 | 35.3 | 5.5 | 43.8 | 24 |
| 20191-20-08 | M20X1.5 | 12 | 08 | 41 | 5.5 | 52 | 27 |
| 20191-22-06T | M22X1.5 | 10 | 06 | 35.8 | 5 | 76.8 | 27 |
| 20191-22-08 | M22X1.5 | 12 | 08 | 42.5 | 5 | 54.5 | 27 |
| 20191-24-08T | M24X1.5 | 12 | 08 | 41 | 5.5 | 51 | 30 |
| 20191-24-10 | M24X1.5 | 16 | 10 | 58 | 5 | 58.5 | 30 |
| 20191-27-10DT | M27X1.5 | 16 | 10 | 56 | 5.5 | 55.5 | 32 |
| 20191-27-10T | M27X2 | 16 | 10 | 56 | 5.5 | 55.5 | 32 |
| 20191-30-12D | M30X1.5 | 20 | 12 | 67.5 | 6 | 68.5 | 36 |
| 20191-30-12 | M30X2 | 20 | 12 | 67.5 | 6 | 68.5 | 36 |
| 20191-36-12T | M36X2 | 20 | 12 | 65.5 | 7 | 68 | 41 |
| 20191-36-14T | M36X2 | 22 | 14 | 71.2 | 7 | 69 | 4 |
| 20191-39-16T | M39X2 | 25 | 16 | 76.7 | 7 | 73.5 | 14 |
| 20191-45-20T | M45X2 | 32 | 20 | 91.5 | 8.5 | 85 | 655 |
| 20191-52-24T | M52X2 | 40 | 24 | 109.4 | 9 | 100 | 60 |
| 20191-64-32T | M64X2 | 50 | 32 | 131.75 | 14 | 122.3 | 75 |

注: 1. 上述代号用于编织软管。 2. 如需用于缠绕软管代号改为 20192-xx-xx。

NOTE : 1. FOR USE WITH BRAIDED HOSES 2. IF USE WITH SPIRAL HOSES , HOSE FITTINGS SERIES NUMBER IS 20192-XX-XX.

软管接头 HOSE FITTING

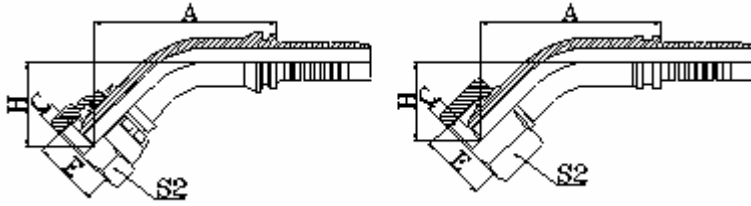

45° 公制内螺纹球面
45° METRIC FEMALE MULTISEAL

20141

20141-T

| 代 号 | 螺纹 E | 软 管 | | 尺 寸 | | | |
|---------------|---------|------|-----|-------|-----|-------|----|
| | | 公称内径 | 标 号 | A | C | H | S2 |
| 20141-10-03 | M10X1 | 5 | 03 | 41.1 | 2.5 | 20.7 | 14 |
| 20141-10-04 | M10X1 | 6 | 04 | 43.2 | 2.5 | 21.5 | 14 |
| 20141-12-03 | M12X1.5 | 5 | 03 | 40.9 | 4 | 21.2 | 17 |
| 20141-12-04 | M12X1.5 | 9 | 04 | 43 | 4 | 22 | 17 |
| 20141-14-04 | M14X1.5 | 6 | 04 | 43.4 | 4.5 | 21.3 | 19 |
| 20141-14-05 | M14X1.5 | 8 | 05 | 45.5 | 4.5 | 22.2 | 19 |
| 20141-16-04 | M16X1.5 | 6 | 04 | 44.7 | 4.5 | 23.2 | 22 |
| 20141-16-05 | M16X1.5 | 8 | 05 | 45.8 | 4.5 | 22.5 | 22 |
| 20141-16-06 | M16X1.5 | 10 | 06 | 47.4 | 4.5 | 24.1 | 22 |
| 20141-18-05T | M18X1.5 | 8 | 05 | 46.8 | 4 | 22.6 | 24 |
| 20141-18-06 | M18X1.5 | 10 | 06 | 48.5 | 4 | 24.2 | 24 |
| 20141-18-08 | M18X1.5 | 12 | 08 | 52.2 | 4 | 25.7 | 24 |
| 20141-20-06T | M20X1.5 | 10 | 06 | 48.2 | 5.5 | 23.9 | 27 |
| 20141-20-08 | M20X1.5 | 12 | 08 | 62.1 | 5.5 | 27.2 | 27 |
| 20141-22-06T | M22X1.5 | 10 | 06 | 58.4 | 5 | 25.7 | 27 |
| 20141-22-08 | M22X1.5 | 12 | 08 | 62.1 | 5 | 27.2 | 27 |
| 20141-24-08T | M24X1.5 | 12 | 08 | 61.1 | 5.5 | 26.1 | 30 |
| 20141-24-10 | M24X1.5 | 16 | 10 | 75.4 | 5 | 29.6 | 30 |
| 20141-27-10DT | M27X1.5 | 16 | 10 | 74.4 | 5.5 | 29.6 | 32 |
| 20141-27-10T | M27X2 | 16 | 10 | 74.4 | 5.5 | 29.6 | 32 |
| 20141-30-12D | M30X1.5 | 20 | 12 | 80.9 | 6 | 33.5 | 36 |
| 20141-30-12 | M30X2 | 20 | 12 | 80.9 | 6 | 33.5 | 36 |
| 20141-36-14T | M36X2 | 22 | 14 | 83 | 7 | 32.64 | 41 |
| 20141-39-16T | M39X2 | 25 | 16 | 88.2 | 7 | 33.95 | 46 |
| 20141-45-20T | M45X2 | 32 | 20 | 99.1 | 8.5 | 38.4 | 55 |
| 20141-52-24T | M52X2 | 40 | 24 | 114.1 | 9 | 43.4 | 60 |

注: 1.上述代号用于编织软管。 2. 如需用于缠绕软管代号改为 20142-xx-xx。

NOTE : 1. FOR USE WITH BRAIDED HOSES 2. IF USE WITH SPIRAL HOSES , HOSE FITTINGS SERIES NUMBER IS 20142-XX-XX.