

WEIGHING*SENSING*MEASUREMENT

TWCSB

Applications:

- Truck and railroad track scales. Tank, bin and silo weighing etc.
- Interchangeable with Celtron CSB

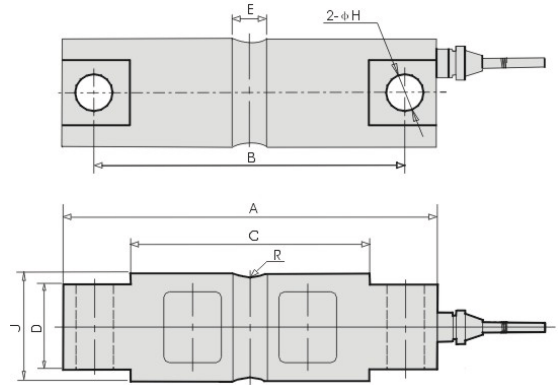

Load(Klb)	A	B	C	D	E	R	J	H
5~10	206.2mm	174.7mm	133.2mm	28.4mm	15.7mm	R12.7mm	43.2mm	16.8mm
15~20	206.2mm	174.7mm	133.2mm	28.4mm	21.3mm	R12.7mm	49.5mm	16.8mm
30~60	206.4mm	215.9mm	165mm	60.2mm	25.4mm	R25.4mm	76.2mm	27mm
100	285.8mm	241.3mm	190.2mm	63.5mm	31mm	R38.1mm	88.9mm	27mm

PRODUCT PARAMETER

CAPACITY: 5Klb-100Klb

Rated output	3.0mV/V±0.25%	Zero balance	±1% F.S
Accuracy Class	C3	Input resistance	700±10Ω
Non-linearity	0.017% F.S	Output resistance	700±5Ω
Hysteretic	0.02% F.S	Safe overload	150% F.S
Non-repeatability	0.01% F.S	Ultimate overload	300% F.S
Creep in 30 minutes	0.02% F.S	Excitation voltage	10VAC/DC
Temperature effect span	15 PPM / °C of Applied Load	Max. Excitation voltage	30VAC/DC
Temperature effect zero	26 PPM / °C of Applied Load	Insulation resistance	≥5000MΩ(50V DC)
Compensated temperature range	-10°C~40°C	Environmental protection	IP67
Operating temperature range	-40°C~65°C	Material	Alloy Steel Stainless Steel
Cable wires			
●Red] +input [●Green] +output [●Black] -input [●White] -output			

ALL THE SPECIFICATIONS ARE SUBJECT TO CHANGE WITHOUT PRIOR NOTICE
 SENTECHS CO., LIMITED WWW.SENSORTECHNICS.COM
 TEL: +86-574-66267500 FAX: +86-574-62805266