

No-cassette Awning F-02

No-cassette Awning F-02 is suitable for large size of retractable awning, because its arms are extremely strong and can be stand more weight.







150-550cm



100-300cm









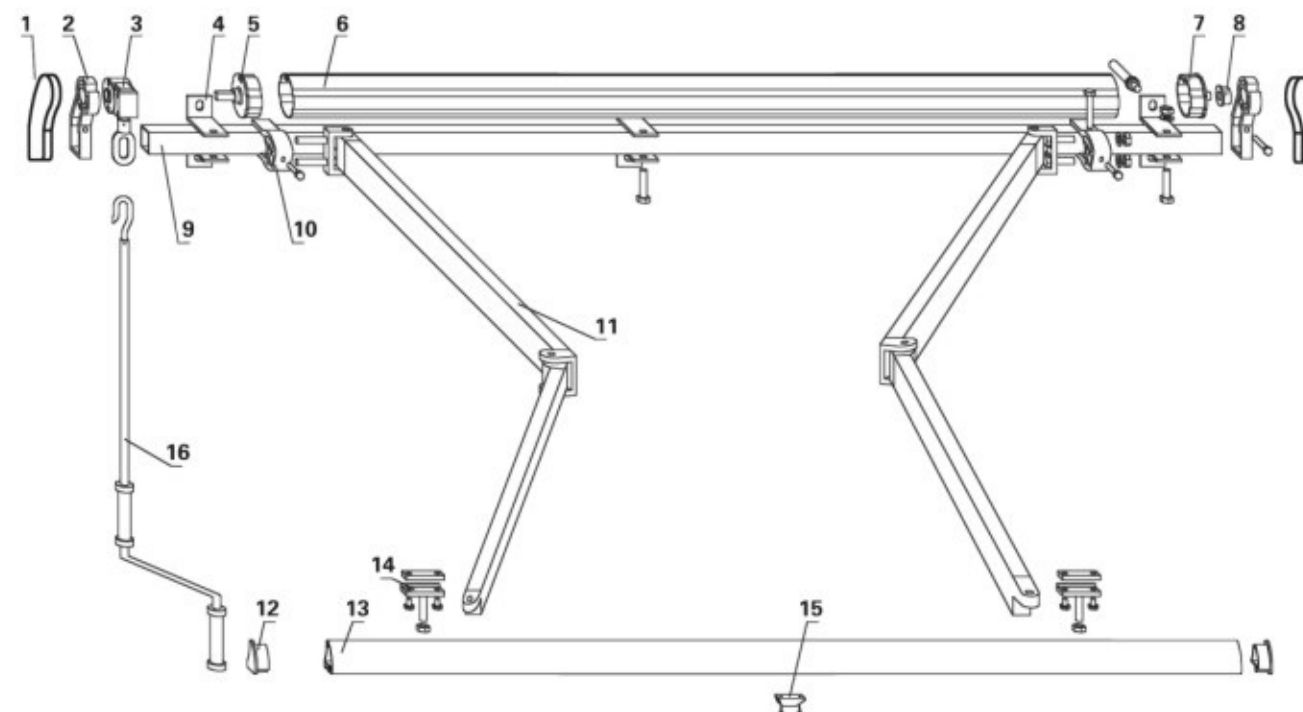









Options

Rain Cover	Aluminum or Metal	Fabric	Polyester or Acrylic
Arm Adjustor	 40mm	Frame Color	 RAL 9010  RAL 9004  RAL 1014
Weather Sensor		Operation	  

F-02 Awning Diagram



NO.	1	2	3	4	5	6	7	8
Name	R.S. End Cap	Roller Stand	Gear Box	Wall Bracket	Square Shaft	Roller	Round Shaft	Shaft Bushing
Diagram								
NO.	9	10	11	12	13	14	15	16
Name	Torsion Bar	Arm Shoulder	Arm	F.B. End Cap	Front Bar	F.B. Hinged Support	Spirit Level	Hand-crank
Diagram								

F-02 Awning Details

Specification	Size	N.W./G.W.	Packing Size	40GP
Max:550 x 300cm	5.50 X 3.00m	30.0/35.0Kgs	5540X185X165mm	320+PCS
Min: 150 x 100cm	4.95 X 3.00m	30.0/35.0Kgs	4990X185X165mm	320+PCS
Torsion Bar :	4.50 X 3.00m	26.0/31.0Kgs	4540X185X165mm	320+PCS
40 x 40mm	4.50 X 2.50m	26.0/31.0Kgs	4540X185X165mm	320+PCS
40 x 40mm	4.50 X 2.00m	25.0/30.0Kgs	4540X185X165mm	320+PCS
Alu. Roller : φ78mm	3.95 X 3.00m	22.5/27.5Kgs	3990X185X165mm	488+PCS
Alu. Front Bar:	3.95 X 2.50m	21.5/26.5Kgs	3990X185X165mm	488+PCS
55.2 x 42.2mm	3.95 X 2.00m	21.5/26.5Kgs	3990X185X165mm	488+PCS
Alu. Support Arms:	3.50 X 3.00m	21.0/26.0Kgs	3540X185X165mm	488+PCS
59 x 31mm	3.50 X 2.50m	20.0/25.0Kgs	3540X185X165mm	488+PCS
51 x 26mm	3.50 X 2.00m	20.0/25.0Kgs	3540X185X165mm	488+PCS
	2.95 X 2.50m	18.0/22.0Kgs	2990X185X165mm	644+PCS
	2.95 X 2.00m	17.0/21.0Kgs	2990X185X165mm	644+PCS
	2.50 X 2.00m	17.5/21.5Kgs	2540X185X165mm	644+PCS
	2.50 X 1.50m	17.0/21.0Kgs	2540X185X165mm	644+PCS
	1.95 X 1.50m	15.0/19.0Kgs	1990X185X165mm	1000+PCS
	1.50 X 1.00m	14.0/18.0Kgs	1540X185X165mm	1250+PCS