

Open Awning F-01

Open Awning F-01 is one promotional style and especially suitable for supermarket promotion. It is better to make small sizes, then we can load more products in the container for you.



200-400cm



150-250cm

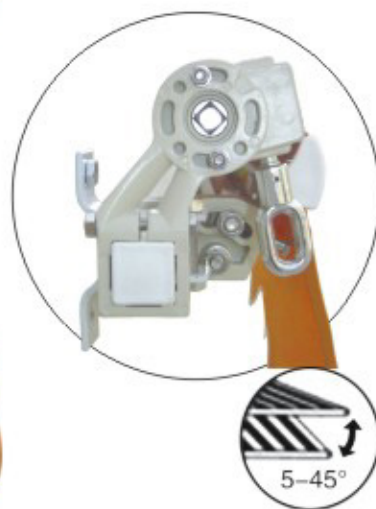







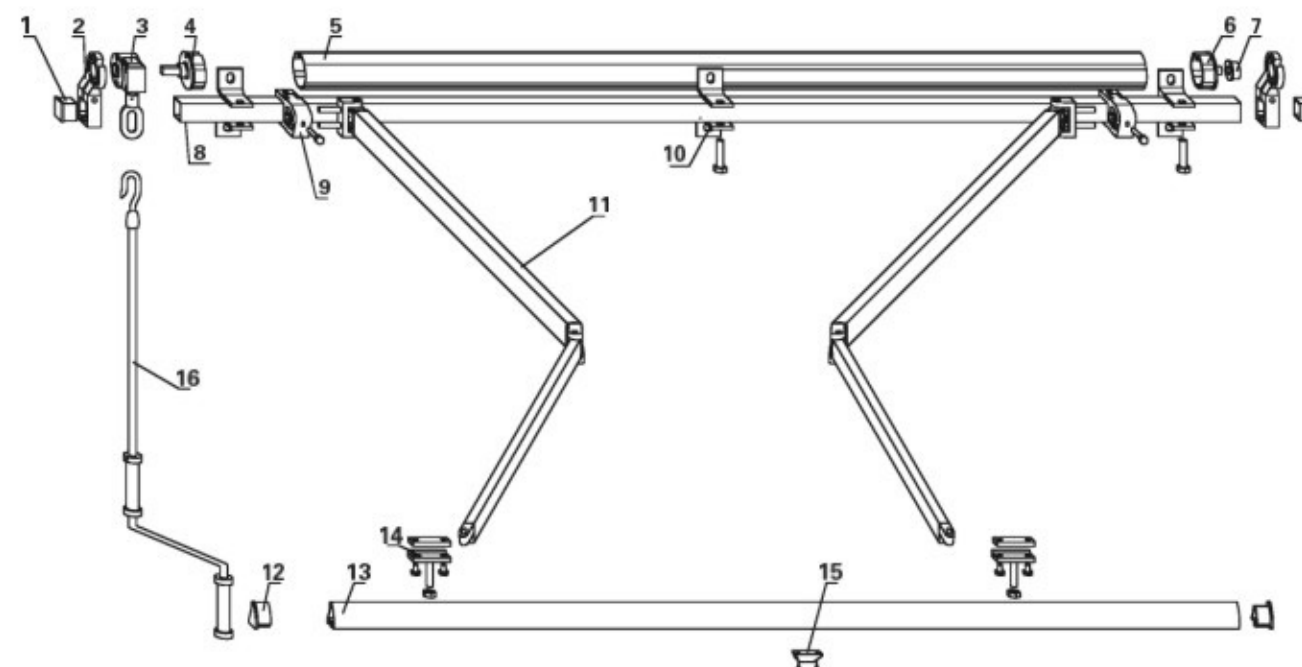









Options

Rain Cover	Aluminum or Metal	Fabric	Polyester or Acrylic
Arm Adjustor	 35mm	Frame Color	 RAL 9010  RAL 9004  RAL 1014
Weather Sensor		Operation	  

F-01 Awning Diagram



NO.	1	2	3	4	5	6	7	8
Name	T.B. End Cap	Roller Stand	Gear Box	Square Shaft	Roller	Round Shaft	Shaft Bushing	Torsion Bar
Diagram								
NO.	9	10	11	12	13	14	15	16
Name	Arm Shoulder	Wall Bracket	Arm	F.B. End Cap	Front Bar	F.B. Hinged Support	Spirit Level	Hand-crank
Diagram								

F-01 Awning Details

Specification	Size	N.W./G.W.	Packing Size	40GP
Max: 400 x 250cm	3.95 X 2.50m	20.5/23.5Kgs	3990 X175 X150mm	580+PCS
Min: 200 x 150cm	3.95 X 2.00m	20.5/23.5Kgs	3990 X175 X150mm	580+PCS
Torsion Bar : 35 x 35mm	3.50 X 2.50m	19.0/22.0Kgs	3540 X175 X150mm	580+PCS
Alu. Roller : φ60mm	3.50 X 2.00m	19.0/22.0Kgs	3540 X175 X150mm	580+PCS
Alu. Front Bar:	2.95 X 2.50m	17.0/20.0Kgs	2990 X175 X150mm	770+PCS
47.2 x 35.6mm	2.95 X 2.00m	16.5/20.0Kgs	2990 X175 X150mm	770+PCS
Alu. Support Arms:	2.50 X 2.00m	15.5/18.5Kgs	2540 X175 X150mm	770+PCS
47 x 28mm	2.50 X 1.50m	15.0/18.5Kgs	2540 X175 X150mm	770+PCS
37 x 20mm	1.95 X 1.50m	13.0/16.0Kgs	1990 X175 X150mm	1170+PCS